



at&t

User's manual

TL86109

DECT 6.0 2-line

**corded/cordless telephone/
answering system with**

BLUETOOTH® wireless technology



Congratulations

on purchasing your new AT&T product. Before using this AT&T product, please read **Important safety information** on pages 151-152 of this user's manual. Please thoroughly read the user's manual for all the feature operations and troubleshooting information you need to install and operate your new AT&T product. You can also visit our website at **www.telephones.att.com** or call **1 (800) 222-3111**. In Canada, dial **1 (866) 288-4268**.

Model number: TL86109 (one handset)
Type: DECT 6.0 2-line corded/cordless telephone/
answering system with Bluetooth® wireless technology
Serial number: _____
Purchase date: _____
Place of purchase: _____

Both the model and serial numbers of your AT&T product can be found on the bottom of the telephone base.



Telephones identified with this logo have reduced noise and interference when used with most T-coil equipped hearing aids and cochlear implants. The TIA-1083 Compliant Logo is a trademark of the Telecommunications Industry Association. Used under license.



The ENERGY STAR® program (www.energystar.gov) recognizes and encourages the use of products that save energy and help protect our environment. We are proud to mark this product with the ENERGY STAR® label indicating it meets the latest energy efficiency guidelines.

The Bluetooth® word mark and logos are owned by Bluetooth SIG, Inc. and any use of such marks by Advanced American Telephones and its parent, VTech Holdings Limited, is under license. VTech Holdings Limited is a member of Bluetooth SIG, Inc. Other trademarks and trade names are those of their respective owners.

© 2010-2011 Advanced American Telephones. All Rights Reserved. AT&T and the AT&T logo are trademarks of AT&T Intellectual Property licensed to Advanced American Telephones, San Antonio, TX 78219. Printed in China.

Parts checklist

Your telephone package contains the following items. Save your sales receipt and original packaging in the event warranty service is necessary.



User's manual



Quick start guide



Cordless handset



Telephone base



Corded handset with coiled handset cord attached



Charger for cordless handset with power adapter installed



Belt clip for cordless handset



Battery for cordless handset



Battery compartment cover

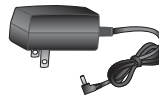

Power adapter for telephone base

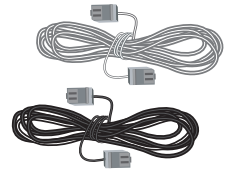

Telephone line cords (one black and one clear)

TL86109
DECT 6.0 2-line
corded/cordless telephone/
answering system with
BLUETOOTH® wireless technology



Table of contents

Getting started

Quick reference guide - handset..... 1
Quick reference guide -
telephone base..... 3
Handset main menu..... 5
Telephone base main menu..... 6
Installation..... 7
Telephone base installation..... 8
Charger installation &
data port use.....10
Battery installation and charging....11
Battery charging.....12
Belt clip & optional headset.....13

Bluetooth

Introducing Bluetooth.....14
Glossary of terms.....15
Bluetooth setup.....16
 Pair a cell phone.....16
 Pair a headset.....18
 Paired devices.....20
 Rename a paired device.....20
 Remove a paired device.....21
 View information of a paired
 device.....21
 Active devices.....22
 Review the active devices list.....22
 Connect/disconnect an active
 device.....23
 Replace an active device.....24
 Add a device on the active
 devices list.....25
 Remove a device from the
 active devices list.....26

View information of an active
device.....26
Change PIN.....27
Download directory.....28
Interruption to directory
download.....29
View the directory download
information.....30

Telephone settings

Handset settings.....31
 Ringer volume.....31
 Ringer tone.....32
 LCD language.....32
 Line preference.....33
 Display alerts.....33
 Key tone.....36
 Set date/time.....37
 Use caller ID to automatically
 set date and time.....38
 Dial mode.....38
 Website.....38
 Home area code.....39
 Cell area code.....40
Telephone base settings.....41
 Ringer volume.....41
 Ringer tone.....42
 LCD language.....42
 Line preference.....43
 Display alerts.....43
 Key tone.....46
 Set date/time.....47
 Use caller ID to automatically
 set date and time.....48
 Dial mode.....48

Table of contents

Website.....	49	Redial.....	80
Home area code.....	49	Review the redial list.....	80
Cell area code.....	50	Dial a redial entry.....	80
Answering system settings.....	51	Save a redial entry to the directory.....	81
Announcement	51	Delete a redial entry.....	82
Answer ON/OFF.....	59	Handset locator.....	83
Call screening.....	61	Multiple handset use	
Number of rings.....	62	Share an outside call.....	84
Remote access code.....	63	Join a call in progress.....	84
Message alert tone.....	64	Intercom.....	85
Recording time.....	65	Call transfer using intercom.....	89
Telephone operation		Directory	
Make, answer and end a call.....	66	About the directory.....	92
Make, answer or end a call on line 1 or line 2.....	66	Create and review entries.....	93
Call waiting on line 1 or line 2 call.....	68	Create a new entry in the home directory	93
Make, answer or end a cell call	68	Add a predialed telephone number to the directory.....	96
Call waiting on the cell line.....	69	Review the directory.....	98
Answer an incoming cell call while on line 1 or line 2	70	3-character alphabetical search.....	99
Answer an incoming call on line 1 or line 2 while on a cell call.....	71	Dial, edit or delete a directory.....	100
Conference calls.....	72	Dial a directory entry.....	100
Conference calls on line 1 and line 2.....	72	Edit a directory entry.....	101
Answer an incoming call on line 1 or line 2 during a conference call.....	73	Edit the type of a directory entry.....	103
Conference call on line 1 or line 2 with a cell call.....	74	Delete a directory entry.....	103
Options while on calls.....	75	Remove a downloaded directory.....	104
Speakerphone	75	Speed dial directory.....	105
Dial-in-Base Speakerphone	75	Store a speed dial directory entry.....	105
Volume control	75	Review the speed dial directory.....	106
Silencing the ringer.....	75	Dial a speed dial entry.....	106
Mute	76	Reassign a speed dial entry.....	106
Temporary tone dialing	76	Delete a speed dial entry.....	107
Hold.....	77	Caller ID	
Equalizer.....	77	About caller ID	108
Chain dialing.....	78	Information about caller ID with call waiting.....	108

Table of contents

Caller ID operation	109	Screen messages.....	130
How the caller ID history (call log) works.....	109	Display screen messages.....	130
Missed call indicator	109	Adding and using a DECT 6.0 cordless headset.....	133
Memory match.....	110	Add a DECT 6.0 cordless headset to your telephone system.....	133
Review the call log.....	110	Expand your telephone system.....	135
View dialing options.....	112	Add and register a handset	135
Dial a call log entry.....	112	Replace a handset.....	136
Save a call log entry to the directory.....	113	Troubleshooting.....	137
Delete from the call log.....	115	Maintenance.....	150
Reasons for missing caller ID information	116	Important safety information	151
Answering system		Safety information.....	151
About the answering system.....	117	Especially about corded telephones.....	151
Answering system and voicemail.....	117	Precautions for users of implanted cardiac pacemakers.....	152
Answering system new message indication.....	118	Pacemaker patients.....	152
Message capacity	118	Especially about telephone answering systems.....	152
Voice prompts	118	FCC Part 68 and ACTA.....	153
Call screening.....	119	FCC Part 15.....	154
Call intercept.....	119	Limited warranty.....	155
Temporarily turning off the message alert tone.....	119	Technical specifications	157
Message playback.....	120	DECT 6.0 digital technology.....	157
Delete all old messages.....	122	Telephone operating range	157
Record, play and delete memos	123	Extended range and clarity	157
Remote access.....	125	Index	
To remotely access the answering system.....	125	Index.....	158
Remote commands.....	125		
Appendix			
Handset screen icons.....	126		
Telephone base screen icons.....	127		
Alert tones and lights	128		
Handset alert tones.....	128		
Telephone base alert tones.....	128		
Handset indicator lights.....	128		
Telephone base indicator lights	129		

Quick reference guide - handset

Softkeys (2)

Press to select a menu item displayed above the key.

CHARGE light (blue ring around DIR/▲/VOL/▼/CID)

On when the handset is charging in the charger.

DIR/▲/VOL

Press to scroll up while in menus.

Press to increase the volume level during a call (page 75).

Press to show directory entries when the telephone is not in use (page 98).

While entering names or numbers, press to move the cursor to the right.

CELL

Press to make or answer a cell call (page 68).

Flashes quickly when there is an incoming cell call.

Flashes slowly when a cell call is on hold.

1 LINE/FLASH

Press **1 LINE/FLASH** to make or answer a call on line 1 (page 66). During a call, press to answer an incoming call on line 1 when you receive a call waiting alert (page 68).

1

While reviewing a caller ID history entry, press repeatedly to add or remove 1 in front of the telephone number before dialing or saving it in the directory (page 112).

TONE ✕

Press to switch to tone dialing temporarily during a call if you have pulse service (page 76).

)/SPEAKER

Press to turn on the handset speakerphone. Press again to resume normal handset use (page 75).

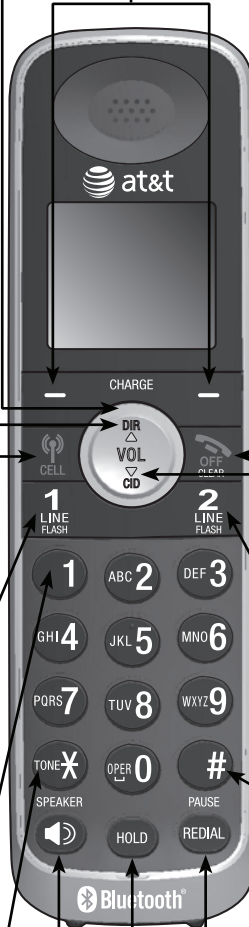

OFF/CLEAR

While using menus, press to cancel an operation, back up to the previous menu, or exit the menu display (page 5).

Press and hold to return to idle mode.

While entering names or numbers, press to delete a digit or a character.

During a call, press to hang up (pages 66 and 68).

VOL/▼/CID

Press to scroll down while in menus.

Press to decrease the volume level during a call (page 75).

Press to show the caller ID history when the telephone is not in use (page 110).

While entering names or numbers, press to move the cursor to the left.

2 LINE/FLASH

Press **2 LINE/FLASH** to make or answer a call on line 2 (page 66). During a call, press to answer an incoming call on line 2 when you receive a call waiting alert (page 68).

(pound key)

Press repeatedly to display other dialing options when reviewing a caller ID history entry (page 112).

REDIAL/PAUSE

Press to view the redial list (page 80).

While entering numbers, press and hold to insert a dialing pause.

HOLD

Press to put a call on hold (page 77).

Getting started
Quick reference guide - handset



EQ 

During an outside call, intercom call, message or announcement playback, press to change the quality of the audio to best suit your hearing (page 77).



Press the **MENU** softkey to enter the main menu which includes the following:

- PLAY MESSAGES (page 120)
- ANSWERING SYS (page 51)
- DIRECTORY (page 93)
- CALL LOG (page 110)
- INTERCOM (page 85)
- RINGER (page 31)
- SETTINGS (page 32)
- WEBSITE (page 38)



Getting started
 Quick reference guide - telephone base



▼CID

Press to scroll down while in a menu.
 Press to review the call log when the telephone is not in use (page 111).
 While entering names or numbers, press to move the cursor to the left.

CANCEL

While in a menu, press to exit without making changes or press and hold to return to idle mode.
 While entering names or numbers, press to delete a digit or a character.

Softkeys (2)

Press to select the menu item displayed above the key.

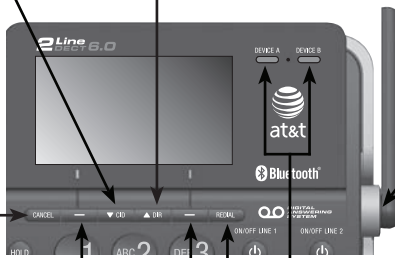

▲DIR

Press to scroll up while in a menu.
 Press to show directory entries when the telephone is not in use (page 98).
 While entering names or numbers, press to move the cursor to the right.

Antenna light

On when the cell line is in use.
 Flashes quickly when there is an incoming cell call.

DEVICE A and DEVICE B lights

On when the telephone base is paired and connected with a Bluetooth device.
 Flash alternately while pairing a Bluetooth device.

REDIAL

Press to review the redial list (page 80).

Quick reference guide - telephone base

◀/REPEAT

During message playback, press to repeat a message, or press twice to play the previous message (page 121).
While entering names or numbers, press to move the cursor to the left.

⌘ TONE X

Press to switch to tone dialing temporarily during a call if you have pulse service (page 76).

HOLD

Press to put a call on hold (page 77).

▼ VOLUME ▲

Press to adjust the volume during playback (page 121).

Press to adjust the volume during a call (page 75).

When the phone is not in use, press to adjust the telephone base ringer volume for all lines (page 41).

FLASH

During a call, press to answer an incoming call when you receive a call waiting alert (page 68).

SPEAKER 🗣️

Press to switch between the speakerphone and the corded handset (page 75).

Press to switch a call from the Bluetooth headset to speakerphone (page 67).

Press to switch the base speakerphone on or off (page 75).

HEADSET 📞

Press to transfer a call from the telephone base to a connected Bluetooth headset (page 67).

Press to use a connected Bluetooth headset (page 67).

Press to end a call while you are using the Bluetooth headset (page 67).

▶/DELETE

Press to delete the message currently playing (page 121).

When the phone is not in use, press to enter a menu to delete all old messages (page 122).

Press to scroll up while in a menu.

🔌/ON/OFF LINE 1 and 🔌/ON/OFF LINE 2

Press to turn the answering system on or off (page 60).

▶/SKIP

During message playback, press to skip to the next message (page 121).

While entering names or numbers, press to move the cursor to the right.

▼/REC

Press to record a memo (page 124) or announcement (page 57).

Press to scroll down while in a menu.

1 LINE ▶/▶/MAILBOX and 2 LINE ▶/▶/MAILBOX

Press to start or stop message playback (page 121).

1 LINE and 2 LINE

Press to make or answer a call (page 66).

CELLULAR 📶

Press to make or answer a cell call (page 69).



Handset main menu

To enter the main menu:

1. Press the **MENU** softkey in idle mode to enter the main menu.
2. Press **▲** or **▼** to select a handset feature menu, then press the **SELECT** softkey to enter that menu.

Press **OFF/CLEAR** to cancel an operation, back up to the previous menu or exit the menu display.

To return to idle mode, press and hold **OFF/CLEAR**.

NOTE: If no key is pressed within 30 seconds, the handset automatically returns to idle mode.

PLAY MESSAGES - play messages stored in **Mailbox 1** or **Mailbox 2**.



ANSWERING SYS - play, record, and delete your announcement and memos and change your answering system settings.

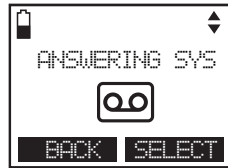

DIRECTORY - store and search for names and numbers.



CALL LOG - review the caller ID history or delete all call log entries.



INTERCOM - intercom call with the telephone base or a system handset.



RINGERS - set up ringers for the home and cell lines.



SETTINGS - change your handset settings.



WEBSITE - view the AT&T website address.



Telephone base main menu

To enter the main menu:

1. Press the **MENU** softkey in idle mode to enter the main menu.
2. Press **▲DIR**, **▼CID**, **▲/DELETE** or **▼/REC** to scroll through menu items.
3. Press the **SELECT** softkey to select the highlighted item.

Press **CANCEL** to cancel an operation, back up to the previous menu or exit the menu display.

To return to idle mode, press and hold **CANCEL**.

i **NOTE:** If no key is pressed within 30 seconds, the telephone base automatically returns to idle mode.

Play messages - play messages stored in **Mailbox 1** or **Mailbox 2**.



Answering sys - play, record, delete your announcement and memos and change your answering system settings.



Directory - store and search for names and numbers.

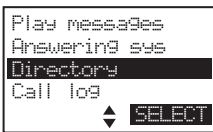

Call log - review the caller ID history or delete all call log entries.



Bluetooth - set up and manage your Bluetooth devices.



Intercom - intercom call with a system handset.



Page all handsets - page the system handset(s).



Ringers - set up ringers for the home and cell lines.



Settings - change your telephone base settings.



Website - view the AT&T website address.



You must install and charge the handset battery before using the cordless handset.



See pages 11-12 for easy instructions.

Install the telephone base close to a telephone jack and a power outlet not controlled by a wall switch. The telephone base should be placed on a flat surface. For optimum range and better reception, place the telephone base in a central and open location.

You may hear interference if your cellular phone is too close to the telephone base during a **CELLULAR** call. Make sure that your Bluetooth enabled cellular phone is within 15 feet of the telephone base in order to maintain a clear and consistent connection between your Bluetooth cell phone, telephone base and cell tower.

If you subscribe to high-speed Internet service (DSL - digital subscriber line) through your telephone line(s), you must install a DSL filter between each telephone line cord and telephone wall jack (pages 8-9). The filter prevents noise and caller ID problems caused by DSL interference. Please contact your DSL service provider for more information about DSL filters.

Your product may be shipped with a protective sticker covering the handset or telephone base display - remove it before use.

For customer service or product information, visit our website at **www.telephones.att.com** or call **1 (800) 222-3111**. In Canada, dial **1 (866) 288-4268**.

Avoid placing the telephone base too close to:

- Communication devices such as television sets, VCRs or other cordless telephones.
- Excessive heat sources.
- Noise sources such as a window with traffic outside, motors, microwave ovens, refrigerators, or fluorescent lighting.
- Excessive dust sources such as a workshop or garage.
- Excessive moisture.
- Extremely low temperature.
- Mechanical vibration or shock such as on top of a washing machine or work bench.

Telephone base installation

If you subscribe to high-speed Internet service (DSL - digital subscriber line) through your telephone line(s), you must install a DSL filter between each telephone line cord and telephone wall jack. The filter prevents noise and caller ID problems caused by DSL interference. Please contact your DSL service provider for more information about DSL filters.

Option 1: If you have a 2-line wall jack, install the telephone base as shown below.

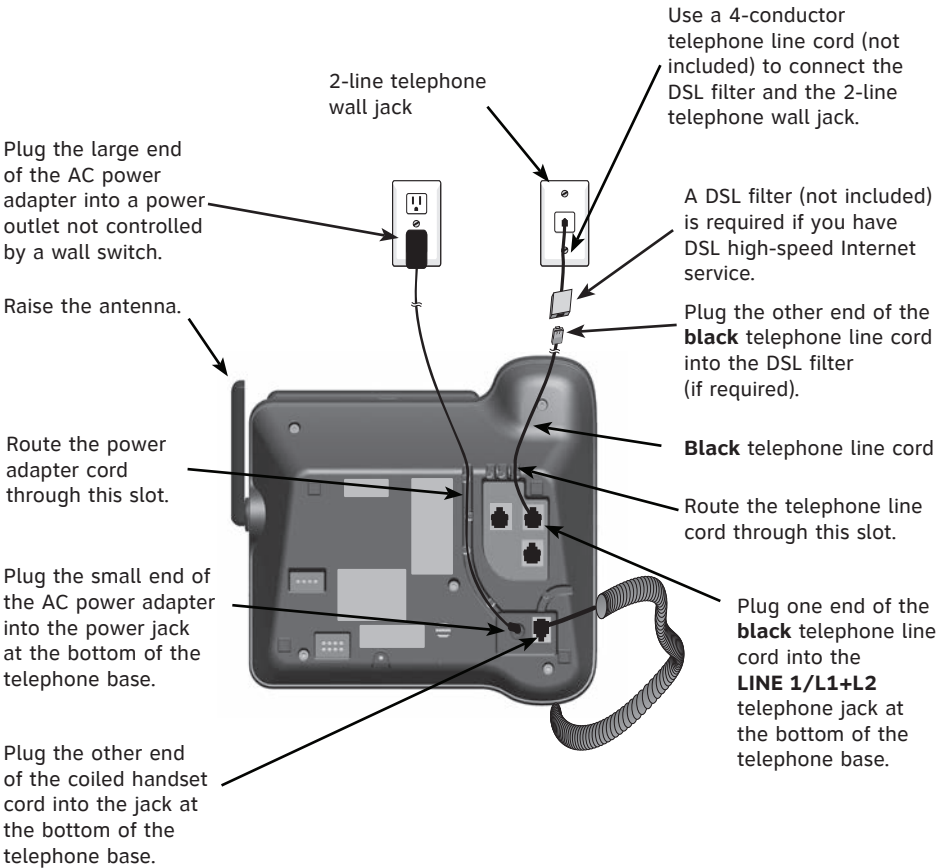

Telephone base installation

Option 2: If you have separate wall jacks for each line, install the telephone base as shown below.

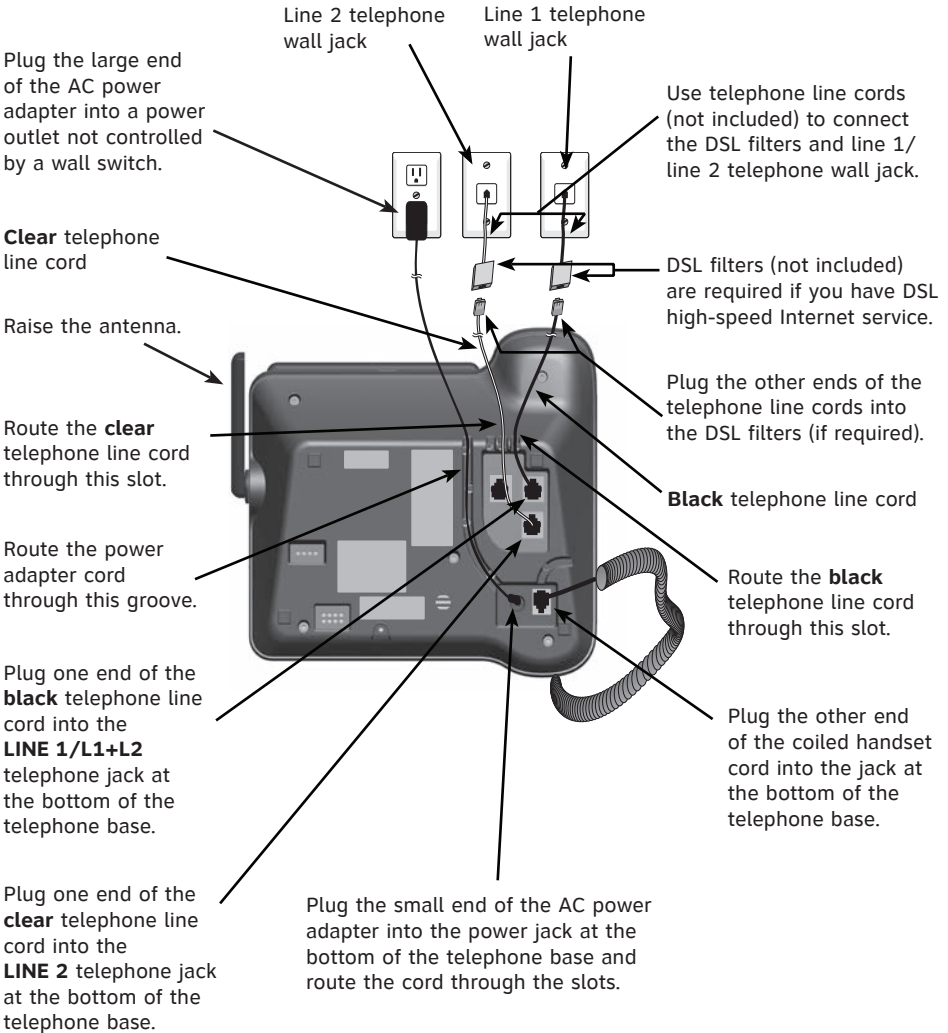

NOTE: This telephone provides minimal functionality during a power outage. When AC power is not available, many telephone features do not function. The telephone uses power from the telephone line to enable you to make and answer calls using only the corded handset and dialing keys. However, only line 1 is available in the event of a power failure.

Charger installation & data port use

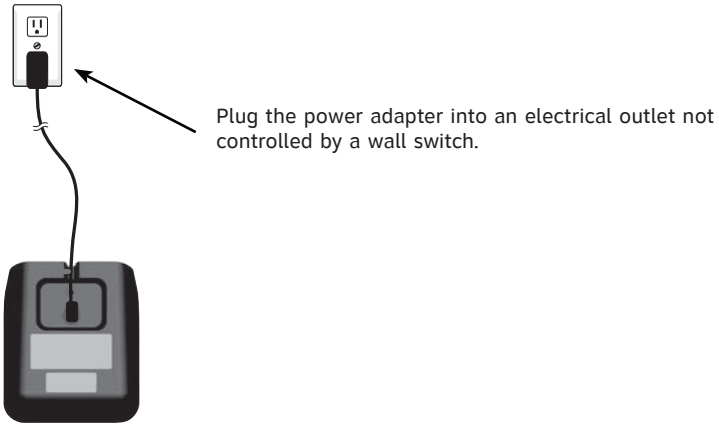

IMPORTANT INFORMATION:

- Use only the power adapters provided with this product. To obtain a replacement, visit our website at www.telephones.att.com or call **1 (800) 222-3111**. In Canada, dial **1 (866) 288-4268**.
- The power adapters are intended to be correctly oriented in a vertical or floor mount position. The prongs are not designed to hold the plug in place if it is plugged into a ceiling, under-the-table or cabinet outlet.

You may connect a fax machine or modem through the **DATA** port located at the back of the telephone base (as shown below).

The **DATA** port only uses **LINE 2** to transmit data.

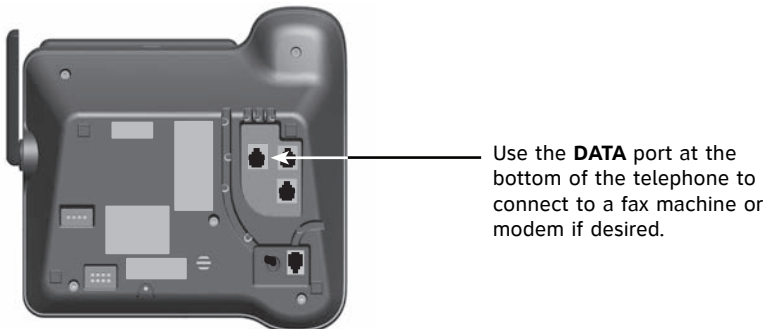

Battery installation and charging

Install the battery as shown below.



Step 1

Plug the battery connector securely into the socket inside the handset battery compartment, matching the color-coded label. Insert the supplied battery with the label **THIS SIDE UP** facing up as indicated.



Step 2

Align the cover flat against the battery compartment, then slide it upwards until it clicks into place.



Step 3

Charge the handset by placing it face up in the charger. The **CHARGE** light is on when charging.

After you install your telephone, the handset will prompt you to set the date and time. For instructions, see **Set date/time** on page 37. To skip setting the date and time, press **OFF/CLEAR**.



To replace the battery, press the tab and slide the battery compartment cover downwards. Lift out the old battery and disconnect it from the handset. Follow the instructions above to install and charge the new battery.



IMPORTANT INFORMATION:

- Use only the supplied rechargeable battery or replacement battery (model BT166342). To order, visit our website at **www.telephones.att.com** or call **1 (800) 222-3111**. In Canada, dial **1 (866) 288-4268**.
- If you do not use the handset for a long time, disconnect and remove the battery to prevent possible leakage.

Battery charging

Once you have installed the battery, the screen indicates the battery status (see table below). If necessary, place the handset in the charger to charge the battery. For best performance, keep the handset in the charger when not in use. The battery is fully charged after 16 hours of continuous charging. See the table on page 157 for battery operating times.

If the screen shows **Low battery**, you need to charge the battery without interruption for at least 25 minutes to give the handset enough charge to use the telephone for a short time. The following table summarizes the battery charge indicators and actions to take.

Battery indicators	Battery status	Action
The screen is blank or shows Place in charger .	The battery has no or very little charge. The handset cannot be used.	Charge without interruption until the screen shows Low battery or HANDSET X (at least 25 minutes).
The screen shows Low battery and  flashes.	Battery has enough charge to be used for a short time.	Charge without interruption until the screen shows HANDSET X (at least 25 minutes).
The screen shows HANDSET X .	Battery is charged.	To keep the battery charged, place it in the charger when not in use.

 **NOTE:** If you are on a phone call in low battery mode, you hear four short beeps every minute.

Getting started
Belt clip & optional headset



To attach the belt clip:
Snap the belt clip into the slots on both sides of the handset as shown in the figure.



To remove the belt clip:
Gently lift either of the belt clip tabs, shown in the figure, outwards to remove the belt clip from the handset.

For handsfree telephone conversations, you can use any industry standard 2.5 mm headset (purchased separately). For best results, use an AT&T 2.5 mm headset. To purchase a headset, visit our website www.telephones.att.com or call **1 (800) 222-3111**. In Canada, dial **1 (866) 288-4268**.

Lift the plastic cover here.



Side of handset

Plug a 2.5 mm headset into the jack on the side of handset (beneath the small plastic cover).



Introducing Bluetooth

Your new AT&T **TL86109** telephone system with Bluetooth wireless technology has the following features:

- Pair up to four Bluetooth enabled devices (cell phones or headsets) with the telephone base.
- Connect a maximum of two cell phones to make and receive cell calls. Only one cell phone can be active on a call at a time.
- Connect a Bluetooth enabled headset for making and receiving line 1 or line 2 calls.
- Conference any combination of cell and line 1 or line 2 calls.
- Make and receive calls using your cell phone plan with your cordless system handsets.

IMPORTANT INFORMATION

- After plugging in the telephone base, wait at least 20 seconds before connecting a Bluetooth device. The screen shows **Bluetooth system busy** if you try to connect too soon.
- Refer to the user's manual of your Bluetooth enabled cell phone or headset for more information about how that device uses Bluetooth connectivity.
- Bluetooth wireless technology operates within a short range (up to 30 feet) from the telephone base. Keep connected cell phones and headset within this range.
- If your cell phone has poor reception in your home, the **TL86109** cannot improve the reception. However, if there is a location in your house with better reception, you can leave your cell phone at that location while you use the **TL86109** cell line. For optimal performance, the cell phone must be within 15 feet of the telephone base.
- Charge your cell phone while it is connected to the telephone base. Your cell phone's battery discharges faster while it is connected to the telephone base via Bluetooth wireless technology.
- Monitor your cell phone's usage because minutes may be deducted from your cellular plan for the duration of all cell calls, depending on the terms of your plan.

Refer to the **Bluetooth setup** section (pages 16-30) to learn how to set up your Bluetooth device. Refer to the **Telephone operation** section (pages 66-83) on how to operate your Bluetooth devices with your new AT&T **TL86109** telephone system with Bluetooth wireless technology. Refer to the **Troubleshooting** section (pages 137-149) if you experience difficulty when using the telephone system.

Glossary of terms

Below are some terms used in this user's manual to help you become familiar with using your Bluetooth devices and your new AT&T telephone system.

Active devices - Bluetooth enabled devices that are paired to the telephone base and on the active devices list. A maximum of two paired devices (two cell phones, or one cell phone and one headset) on the active devices list can be connected to the telephone base, but only one can be on a call at a time.

Bluetooth cell phone - refers to a mobile Bluetooth enabled cellular telephone.

CELLULAR line - the telephone line associated with your cell phone service. On your **TL86109**, press **☎CELL** on the handset or **CELLULAR☎** on the base to use the cell line.

Connected - a Bluetooth enabled device (cell phone or headset) can only be used when it is connected to the telephone base. When a Bluetooth enabled device is connected to the telephone base and listed on the active devices list, it is ready for use.

Device list - The list of devices connected to the telephone.

Disconnected - a diagonal line appears across devices A and/or B when the corresponding Bluetooth enabled device is disconnected from the telephone base.

Discoverable mode - before a Bluetooth enabled device can be paired, it must be set to this mode. When pairing your cell phone, the telephone base is set to this mode. Depending on the cell phone manufacturer, this mode is sometimes referred to as **Find Me** or **Visibility**.

1 LINE and **2 LINE** - your conventional telephone land lines. On your **TL86109**, press **1 LINE/FLASH** or **2 LINE/FLASH** on the handset or **1 LINE** or **2 LINE** on the base to use the corresponding line.

Paired devices - Bluetooth enabled devices (cell phones or headsets) that have shared registration information with the telephone base. A total of four Bluetooth enabled devices can be paired to the telephone base. However, only two paired devices can communicate with the base at a time.

Pairing - sometimes referred to as **bonding**. The process of sharing registration information between two Bluetooth enabled devices. Your Bluetooth enabled cell phone or headset must first be paired to the telephone base in order to use it with this telephone system.

PIN - by default, the PIN is **0000** for the telephone base and for most Bluetooth devices. PIN information must be exchanged between Bluetooth devices before they can be used. This is also known as a **Passkey** or **Passcode**.

Bluetooth setup

To use a Bluetooth enabled cellular phone with your telephone, you must first pair and connect your Bluetooth cellular phone with the telephone base. The **TL86109** can then be used to make or answer calls on the cell phone line.

Bluetooth wireless technology operates within a short range (up to 30 feet). When you pair a Bluetooth cell phone or Bluetooth headset to the telephone base, keep the device within 15 feet of the telephone base for optimal performance.

Pair a cell phone

Before you begin, make sure that you have cellular coverage and your Bluetooth enabled cell phone is not connected to any other Bluetooth device. Refer to your cell phone user's manual to learn how to search for or add new Bluetooth devices.

To pair and connect a cell phone:

1. Press the **MENU** softkey on the telephone base in idle mode to enter the main menu.
2. Press **▲DIR**, **▼CID**, **▲/DELETE** or **▼/REC** to highlight **Bluetooth**, then press the **SELECT** softkey.
3. Press **▲DIR**, **▼CID**, **▲/DELETE** or **▼/REC** to highlight **Add cellular**, then press the **SELECT** softkey. The screen displays **Please set your cell to search for devices then press ↵**. Press the **NEXT** softkey.
 - If there are already four devices on the paired devices list, the screen displays **Device list is full. Replace paired device?** Press the **YES** softkey to confirm and you are prompted to replace an existing paired device (page 24).
 - If a device is already connected to the telephone base, the screen displays **Connected devices will be temporarily disconnected**. Press the **OK** softkey to temporarily disconnect all the connected devices and continue the pairing process.
4. Turn on the Bluetooth feature of your cell phone and search for or add new devices.
5. Once your cell phone finds **AT&T DECT 6.0**, press the appropriate key on your cell phone to continue the pairing process.
6. Enter the PIN of the telephone base (the default PIN is **0000**) into your cell phone.
7. When a device is successfully paired, the telephone base displays **Pairing complete**.

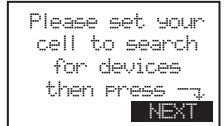

Bluetooth setup

8. The telephone base then displays **Connect cell to base?** Press the **YES** softkey to connect your cell phone to the telephone base. For certain cell phones, you may also need to press a key on your cell phone to confirm the connection. The telephone base displays **Device connected to the base**. The corresponding status icon (📶 **A** or 📶 **B**) displays. The corresponding device light on the telephone base (**DEVICE A** or **DEVICE B**) turns on.

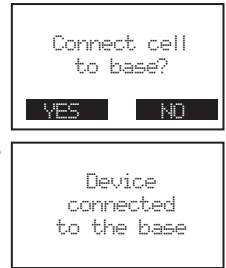

- If you already have two devices on the active devices list, the telephone base screen displays **Max. connectable devices is two** and you are prompted to replace an existing device on the active devices list (page 24).

If you have trouble pairing your cell phone, it may not be compatible with your TL86109. Check the Bluetooth compatibility list at www.telephones.att.com.

NOTES:

- The pairing process may take up to one minute. If the pairing process fails, try again.
- If your Bluetooth device fails to connect with the telephone base, the telephone base displays **Connection failed** and then **Auto-connect function enabled**. Press the **SELECT** softkey and the telephone base will then periodically attempt to connect with your Bluetooth device.
- The steps for the pairing process may vary for different cell phones. If this happens, follow the prompts on your cell phone and your **TL86109** to complete the pairing process.
- Refer to the user's manual of your cell phone on how to search for or add a new Bluetooth device.

Pair a headset

Before you begin, make sure that your Bluetooth enabled headset is not connected to any other Bluetooth device. Refer to your headset user's manual to learn how to search for or add new Bluetooth devices.

To pair and connect a headset:

1. Press the **MENU** softkey on the telephone base in idle mode to enter the main menu.
2. Press **▲DIR**, **▼CID**, **▲/DELETE** or **▼/REC** to highlight **Bluetooth**, then press the **SELECT** softkey.
3. Press **▲DIR**, **▼CID**, **▲/DELETE** or **▼/REC** to highlight **Add headset**, then press the **SELECT** softkey. The screen displays **Pls set headset to discoverable mode then press ↵**.
 - If there are already four devices on the paired devices list, the screen displays **Device list is full. Replace paired device?** Press the **YES** softkey and you are prompted to replace an existing paired device (page 24).
 - If a device is already connected to the telephone base, the screen displays **Connected devices will be temporarily disconnected**. Press the **OK** softkey to temporarily disconnect the device(s) and continue the pairing process.
4. Set your headset to discoverable mode.
5. Press the **NEXT** softkey to set your telephone base to discoverable mode and search for your headset.
6. Once the telephone base finds your headset, press the **SELECT** softkey.
7. Enter the PIN of your headset (the PIN for most Bluetooth devices is **0000**), then press the **NEXT** softkey.
8. If the PIN is correctly entered, the telephone base displays **Headset setup complete**.

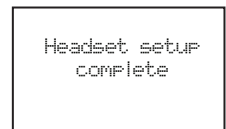
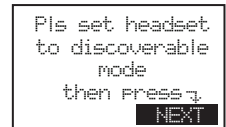

Bluetooth setup

9. The telephone base displays **Connect headset to base?** Press the **YES** softkey to confirm. The telephone base displays **Headset setup completed.** **Device connected.** The corresponding status icon (📶 **A** or 📶 **B**) displays when the headset is successfully connected. The corresponding light on the telephone base (**DEVICE A** or **DEVICE B**) turns on.

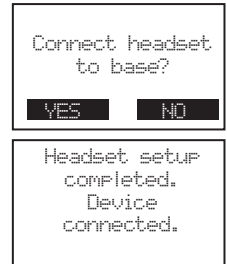

- When you already have two devices on the active devices list, the screen displays **Max. connectable devices is two** and you are prompted to replace an existing device on the active devices list (page 24).
- When you already have one headset on the active devices list, the telephone base shows **Only 1 headset can be connected.** You are prompted to replace the headset on the active devices list. The screen displays **Headset A will be replaced from Active list?** Press the **YES** softkey to replace the existing headset on the active devices list.

If you have trouble pairing your headset, it may not be compatible with your TL86109. Check the Bluetooth compatibility list at www.telephones.att.com.

i **NOTES:**

- The pairing process may take up to one minute. If the pairing process fails, try again.
- If your Bluetooth device fails to connect with the telephone base, the telephone base displays **Connection failed** and then **Auto-connect function enabled**. Press the **SELECT** softkey and the telephone base will then periodically attempt to connect with your Bluetooth device.

Bluetooth setup

Paired devices

All paired devices are stored on the paired devices list. Up to four devices (cell phones and headsets) can be paired with the telephone base.

To use a paired device, it must be on the active devices list (page 22) and connected.

Once you have paired a device to the telephone base, you do not need to repeat the pairing procedure again unless you delete the device from the paired devices list.

NOTE: Only the first 15 characters of the device name are shown on the paired devices list.

Rename a paired device

You can change the name of a paired device on the paired devices list.

1. Press the **MENU** softkey on the telephone base in idle mode.
2. Press **▲/DIR**, **▼/CID**, **▲/DELETE** or **▼/REC** to highlight **Bluetooth**, then press the **SELECT** softkey.
3. Press **▲/DIR**, **▼/CID**, **▲/DELETE** or **▼/REC** to highlight **Paired devices**, then press the **SELECT** softkey.
4. Press **▲/DIR**, **▼/CID**, **▲/DELETE** or **▼/REC** to highlight a device when necessary, then press the **OPTION** softkey.
5. Press **▲/DIR**, **▼/CID**, **▲/DELETE** or **▼/REC** to highlight **Rename**, then press the **SELECT** softkey. The screen displays **ENTER NEW NAME**.
6. Use the dialing keys to edit the name (page 95).
 - Press **CANCEL** to erase a character.
 - Press **▲/DIR** or **▶/SKIP** to move the cursor to the right. Press **▼/CID** or **◀/REPEAT** to move to the left.
7. Press the **SAVE** softkey to confirm. The telephone base displays **Device renamed**.
 - If the name you try to save already exists, the telephone base displays **Device name already exists. Rename device?** Press the **YES** softkey to rename your device.



Bluetooth setup

Remove a paired device

If you want to add another Bluetooth device and you already have the maximum of four devices on the paired devices list, you must first delete a device from the paired devices list.

To remove a paired device:

1. Press the **MENU** softkey on the telephone base in idle mode to enter the main menu.
2. Press **▲DIR**, **▼CID**, **▲/DELETE** or **▼/REC** to highlight **Bluetooth**, then press the **SELECT** softkey.
3. Press **▲DIR**, **▼CID**, **▲/DELETE** or **▼/REC** to highlight **Paired devices**, then press the **SELECT** softkey.
4. Press **▲DIR**, **▼CID**, **▲/DELETE** or **▼/REC** to highlight a device when necessary, then press the **OPTION** softkey.
5. Press **▲DIR**, **▼CID**, **▲/DELETE** or **▼/REC** to highlight **Remove paired**, then press the **SELECT** softkey. The telephone base displays **Remove device from paired list?**
6. Press the **YES** softkey to confirm. The telephone base displays **Device removed from paired list** and you hear a confirmation tone.

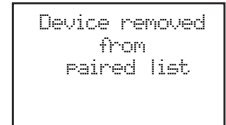

View information of a paired device

To view the information of a paired device:

1. Press the **MENU** softkey on the telephone base in idle mode to enter the main menu.
2. Press **▲DIR**, **▼CID**, **▲/DELETE** or **▼/REC** to highlight **Bluetooth**, then press the **SELECT** softkey.
3. Press **▲DIR**, **▼CID**, **▲/DELETE** or **▼/REC** to highlight **Paired devices**, then press the **SELECT** softkey.
4. Press **▲DIR**, **▼CID**, **▲/DELETE** or **▼/REC** to highlight a device when necessary, then press the **INFO** softkey.
5. The screen displays the information of the device. Press the **OK** softkey to return to the paired devices list.



Active devices

Only devices on the active devices list can establish a Bluetooth connection with the telephone base. Although two active devices can be connected to the telephone base, only one Bluetooth cell phone or a headset can be on a call at a time.

 **NOTE:** When adding, removing, or replacing a Bluetooth device on the active devices list, all connected devices are temporarily disconnected until the procedure is complete. It may take up to two minutes to reconnect.

Review the active devices list

1. Press the **MENU** softkey on the telephone base in idle mode.
2. Press **▲DIR**, **▼CID**, **▲/DELETE** or **▼/REC** to highlight **Bluetooth**, then press the **SELECT** softkey.
3. Press **▲DIR**, **▼CID**, **▲/DELETE** or **▼/REC** to highlight **Active devices**, then press the **SELECT** softkey.

Bluetooth setup

Connect/disconnect an active device

While in the active devices menu, you may connect or disconnect your active device.

1. Press the **MENU** softkey on the telephone base in idle mode.
2. Press **▲DIR**, **▼CID**, **▲/DELETE** or **▼/REC** to highlight **Bluetooth**, then press the **SELECT** softkey.
3. Press **▲DIR**, **▼CID**, **▲/DELETE** or **▼/REC** to highlight **Active devices**, then press the **SELECT** softkey.
4. Press **▲DIR**, **▼CID**, **▲/DELETE** or **▼/REC** to highlight a device when necessary, then press the **OPTION** softkey.
5. Press **▲DIR**, **▼CID**, **▲/DELETE** or **▼/REC** to highlight **Connect/Disconnect** (whichever is applicable), then press the **SELECT** softkey to confirm.

i NOTE: When your active device is connected, you are prompted to select **Disconnect**. When your active device is disconnected, you are prompted to select **Connect**.

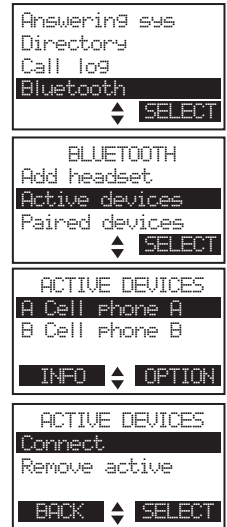

When one or more than one active devices are disconnected, the telephone base displays the **CONNECT** softkey. You may also connect a device to the telephone base with the following steps:

1. Press the **CONNECT** softkey on the telephone base in idle mode.
2. If only one device is disconnected, the telephone base displays **Connecting Cell phone A to the base...**

-OR-

If two devices are disconnected, the telephone base displays the **CONNECT DEVICE** list. Press **▲DIR**, **▼CID**, **▲/DELETE** or **▼/REC** to highlight a device, then press the **SELECT** softkey. The telephone base displays **Connecting Cell phone A to the base...**

3. When the connection is successful, the telephone base displays **Device connected to the base.**

i NOTE: If the connection fails, the telephone base displays **Connection failed** and then **Auto-connect function enabled**. Press the **SELECT** softkey and the telephone base will then periodically attempt to connect with your Bluetooth device.

Bluetooth setup

Replace an active device

When you already have two devices on the active devices list, you can replace an active device with a device that is already on the paired devices list.

To replace an active device:

1. Press the **MENU** softkey on the telephone base in idle mode to enter the main menu.
 2. Press **▲/DIR**, **▼/CID**, **▲/DELETE** or **▼/REC** to highlight **Bluetooth**, then press the **SELECT** softkey.
 3. Press **▲/DIR**, **▼/CID**, **▲/DELETE** or **▼/REC** to highlight **Paired devices**, then press the **SELECT** softkey.
 4. Press **▲/DIR**, **▼/CID**, **▲/DELETE** or **▼/REC** to highlight a device when necessary, then press the **OPTION** softkey.
 5. Press the **SELECT** softkey to choose **Connect**.
 6. The telephone base displays **Max. connectable devices is two** and then **Replace an existing active device with cellular/headset?** Press the **YES** softkey. You are prompted to select a device to be paired on the active devices list. Press **▲/DIR**, **▼/CID**, **▲/DELETE** or **▼/REC** to highlight the desired device, then press the **SELECT** softkey.
- OR-**
- The telephone base displays **Only 1 headset can be connected** and then **Headset X will be replaced from Active list?** if you select a Bluetooth headset on the paired devices list and there is already a Bluetooth headset on the active devices list. Press the **YES** softkey.
7. The telephone base displays **Device removed from active device list** and then **Connecting Cell phone X/Headset X to the base...**
 8. When you successfully replace and connect an active device with a paired device, the telephone base displays **Device connected to the base**. You hear a confirmation tone.

```

Answering sys
Directory
Call log
Bluetooth
  ▲▼ SELECT
  
```

```

BLUETOOTH
Add headset
Active devices
Paired devices
  ▲▼ SELECT
  
```

```

PAIRED DEVICES
Cell phone A
Cell phone B
Cell phone C
  INFO ▲▼ OPTION
  
```

```

PAIRED DEVICES
Connect
Rename
Remove paired
  BACK ▲▼ SELECT
  
```

```

Max. connectable
devices is two
  
```

```

Replace an
existing active
device with
cellular?
  YES NO
  
```

```

REPLACE DEVICE
Headset A
Cell phone B
  ▲▼ SELECT
  
```

```

Device removed
from active
device list
  
```

```

Connecting
Cell phone X
to the base...
  
```

```

Device
connected
to the base
  
```

Add a device on the active devices list

You can have a maximum of two devices on the active devices list.

To add an active device:

1. Press the **MENU** softkey on the telephone base in idle mode to enter the main menu.
2. Press **▲DIR**, **▼CID**, **▲/DELETE** or **▼/REC** to highlight **Bluetooth**, then press the **SELECT** softkey.
3. Press **▲DIR**, **▼CID**, **▲/DELETE** or **▼/REC** to highlight **Active devices**, then press the **SELECT** softkey.
4. Press **▲DIR**, **▼CID**, **▲/DELETE** or **▼/REC** to highlight an empty slot, then press the **ADD** softkey.
5. You are prompted to select a device from the paired devices list.
6. Press **▲DIR**, **▼CID**, **▲/DELETE** or **▼/REC** to select a paired device, then press the **ADD** softkey. The telephone base displays **Device added to active list**.

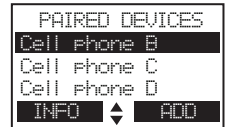

Remove a device from the active devices list

You can remove an active device from the active devices list.

To remove an active device:

1. Press the **MENU** softkey on the telephone base in idle mode to enter the main menu.
2. Press **▲DIR**, **▼CID**, **▲/DELETE** or **▼/REC** to highlight **Bluetooth**, then press the **SELECT** softkey.
3. Press **▲DIR**, **▼CID**, **▲/DELETE** or **▼/REC** to highlight **Active devices**, then press the **SELECT** softkey.
4. Press **▲DIR**, **▼CID**, **▲/DELETE** or **▼/REC** to highlight a device, then press the **OPTION** softkey.
5. Press **▲DIR**, **▼CID**, **▲/DELETE** or **▼/REC** to highlight **Remove active**, then press the **SELECT** softkey. The telephone base displays **Device removed from active device list**.

i **NOTE:** Even though the active device is removed from the active devices list, it is still on the paired devices list.

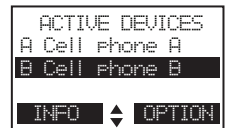

View information of an active device

To view the information of an active device:

1. Press the **MENU** softkey on the telephone base in idle mode to enter the main menu.
2. Press **▲DIR**, **▼CID**, **▲/DELETE** or **▼/REC** to highlight **Bluetooth**, then press the **SELECT** softkey.
3. Press **▲DIR**, **▼CID**, **▲/DELETE** or **▼/REC** to highlight **Active devices**, then press the **SELECT** softkey.
4. Press **▲DIR**, **▼CID**, **▲/DELETE** or **▼/REC** to highlight a device, then press the **INFO** softkey.
5. The screen displays the information of the device. Press the **OK** softkey to return to the active devices list.

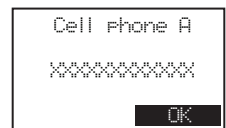
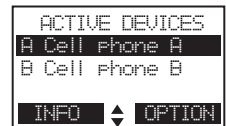

Change PIN

You are required to enter a PIN when establishing a Bluetooth connection. The default PIN of your telephone base is **0000**.

To change the PIN:

1. Press the **MENU** softkey on the telephone base in idle mode to enter the main menu.
2. Press **▲/DIR**, **▼/CID**, **▲/DELETE** or **▼/REC** to highlight **Bluetooth**, then press the **SELECT** softkey.
3. Press **▲/DIR**, **▼/CID**, **▲/DELETE** or **▼/REC** to highlight **Change PIN**, then press the **SELECT** softkey. The telephone base displays **ENTER NEW PIN** and the existing PIN.
4. Use the dialing keys to enter a new four-digit code.
 - Press **CANCEL** to erase a digit.
 - Press **▲/DIR** or **▶/SKIP** to move the cursor to the right. Press **▼/CID** or **◀/REPEAT** to move to the left.
5. Press the **SET** softkey to save.



Download directory

You can download up to four cell phone directories (phonebooks) to your **TL86109** telephone system via Bluetooth wireless technology. Each downloaded directory can store up to 1,500 entries with up to 30 digits for each phone number and 15 characters for each name.

Before downloading the directory, make sure the cell phone is paired to your **TL86109** and is on the active devices list.

Place your cell phone next to the telephone base when you download a cell phone directory to your TL86109.

To download a cell phone directory:

1. Press the **MENU** softkey on the telephone base in idle mode.
2. Press **▲/DIR**, **▼/CID**, **▲/DELETE** or **▼/REC** to highlight **Bluetooth**, then press the **SELECT** softkey.
3. Press the **SELECT** softkey to select **Download dir**.
 - If there is no cell phone paired to the system, the telephone base displays **No cellular device paired**. Press the **ADD** softkey to pair a device.
4. Press **▲/DIR**, **▼/CID**, **▲/DELETE** or **▼/REC** to select a desired device when necessary, then press the **SELECT** softkey.
 - If the selected device is on the paired devices list but not on the active devices list, the telephone base displays **No cellular in active devices list**. Press the **ADD** softkey to add a device to the active devices list.
 - If the selected device is on the active devices list but disconnected, the telephone base displays **Not connected. Place cell near the base to connect**. Press the **NEXT** softkey to connect the device.
 - If the selected device's directory has already been downloaded to the **TL86109** before, the telephone base displays **Cell phone A Last update: MM/DD/YY**. If you press the **NEXT** softkey to continue the download process, the stored directory for that particular cell phone is erased and replaced with the current cell phone directory. The telephone base then displays **Directory Cell phone A will be erased**. Press the **NEXT** softkey to confirm. If you have edited the downloaded entries (page 101), those changes are lost.
 - If you already have four downloaded directories, the telephone base displays **Memory is full. Replace existing directory?** Press the **YES** softkey and the system prompts you to replace an existing directory before downloading.



Bluetooth setup

5. Press **▲/DIR**, **▼/CID**, **▲/DELETE** or **▼/REC** to highlight one of the following options:

- **Phone memory** - download all contacts stored in your phone memory.
- **SIM card only** - download all contacts stored in your SIM card.
- **Phone and SIM** - download all contacts stored in both your phone memory and SIM card.

Press the **SELECT** softkey. During the download, the telephone base displays the progress. All cordless handsets display **LINK IN USE**.

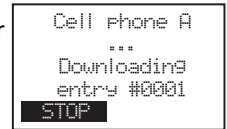

6. When the downloading process is complete, the telephone base displays **Download complete XXXX entries saved**. Press the **OK** softkey to return to the **Bluetooth** menu.

iNOTES:

- With certain cell phones, downloading from the SIM card is not supported. If this is the case, try transferring the contacts from your SIM card to your cell phone memory first, then download from your cell phone memory. For more information on how to transfer contacts from your SIM card to your cell phone memory, see the user's manual of your cell phone.
- If **Phone memory** is chosen but with no entries saved, the telephone base displays **No entries found. Try downloading from SIM memory only?** If **SIM card only** is chosen but with no entries saved, the telephone base displays **No entries found. Try downloading from phone memory only?** If **Phone and SIM** are chosen but with no entries saved in either directories, the telephone base displays **No entries found. Try downloading from phone memory only?**
- When downloading the directory from your Bluetooth enabled cell phone, some data may not transfer. For example, if you have home, mobile and work numbers for a particular contact, the three category descriptions may not transfer to your **TL86109**.
- On certain cell phones, you may need to press a key to confirm the directory download.

Interruption to directory download

When you are downloading a directory from a cell phone and you receive a call on your cell phone, line 1 or line 2, the download process stops. After the call, the telephone base displays **Download fail**. When you try to view the downloaded directory, the telephone base displays **Cell phone A Last download failed: MM/DD/YY**. You need to download the directory again (see page 28).

When you are downloading a directory from a cell phone and you wish to stop the download process, you may press the **STOP** softkey. Then the telephone base displays **Download directory cancelled**. The telephone base displays **Download fail** when it returns to idle mode.

i**NOTE:** During the download process, do not attempt to make changes to your cell phone directory.

Bluetooth setup

View the directory download information

1. Press the **MENU** softkey on the telephone base in idle mode to enter the main menu.
2. Press **▲DIR**, **▼CID**, **▲/DELETE** or **▼/REC** to highlight **Directory**, then press the **SELECT** softkey.
3. Press **▲DIR**, **▼CID**, **▲/DELETE** or **▼/REC** to choose the desired downloaded directory, then press the **SELECT** softkey.
4. Press **▲DIR**, **▼CID**, **▲/DELETE** or **▼/REC** to highlight **Last update**, then press the **SELECT** softkey.
 - The telephone base displays **Cell phone A Last update: MM/DD/YY Total #XXXX**.
 - OR-
 - The telephone base displays **Cell phone A Last download failed: MM/DD/YY** if there was an interruption during that directory download.

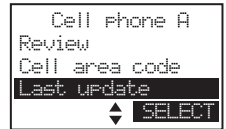

Ringer volume

You can select the ringer volume for incoming calls on line 1, line 2 and the cell line.

To adjust the handset ringer volume:

1. Press the **MENU** softkey on the handset in idle mode to enter the main menu.
2. Press **▲** or **▼** to highlight **RINGERS**, then press the **SELECT** softkey.
3. Press the **SELECT** softkey to choose **Ringer volume**.
4. Press **▲** or **▼** to select **All lines**, **Line 1**, **Line 2**, **Cell A** or **Cell B**, then press the **SELECT** softkey to confirm.
5. Press **▲** or **▼** to adjust the ringer volume. A sample of each ringer volume plays as you scroll through the choices.

-OR-

Press the **OFF** softkey to turn off the ringer. The handset displays **Ringer muted**.

6. Press the **SET** softkey to confirm. You hear a confirmation tone.

NOTES:

- Changing the handset ringer volume does not affect the telephone base ringer volume. For more information on base ringer volume, see page 41.
- When the ringer volume of line 1 or line 2 is set to off, the handset displays **Ringer off** for the corresponding line. When the ringer volume of **Cell A** or **Cell B** is set to off, the handset displays **Ringer A off** or **Ringer B off** respectively. When the ringer volume of all cell calls is set to off, the handset displays **Ringers off**.
- The ringer volume of line 1 determines the ringer volume of intercom calls (page 85).

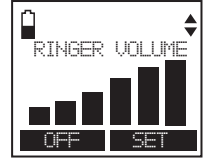

Handset settings

Ringer tone

You can select the ringer tones for incoming calls on line 1, line 2 and the cell line.

To select a ringer tone:

1. Press the **MENU** softkey on the handset in idle mode to enter the main menu.
2. Press **▲** or **▼** to highlight **RINGERS**, then press the **SELECT** softkey.
3. Press **▲** or **▼** to highlight **Ringer tone**, then press the **SELECT** softkey.
4. Press **▲** or **▼** to select **All lines**, **Line 1**, **Line 2**, **Cell A** or **Cell B**, then press the **SELECT** softkey to confirm.
5. Press **▲** or **▼** to select a ringer tone. A sample of each ringer tone plays as you scroll through the choices.
6. Press the **SET** softkey to confirm. You hear a confirmation tone.

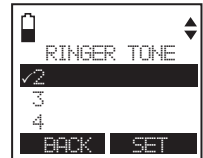

NOTE: If you turn off the ringer volume, you do not hear ringer tone samples.

LCD language

You can select **English**, **Français** or **Español** to be used for all screen displays.

To select a language:

1. Press the **MENU** softkey in idle mode to enter the main menu.
2. Press **▲** or **▼** to highlight **SETTINGS**, then press the **SELECT** softkey.
3. Press the **SELECT** softkey to choose **LCD language**.
4. Press **▲** or **▼** to choose **English**, **Français** or **Español**, then press the **SET** softkey. You hear a confirmation tone.

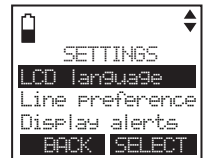

Handset settings

Line preference

The line preference setting determines the default line for the speakerphone on the handset for outgoing calls. You can select **Auto**, **Line 1**, **Line 2** or **Cell** for your call. The **Cell** option will only be available if you have a cell phone paired to the base.

To select a line preference:

1. Press the **MENU** softkey in idle mode to enter the main menu.
2. Press **▲** or **▼** to highlight **SETTINGS**, then press the **SELECT** softkey.
3. Press **▲** or **▼** to highlight **Line preference**, then press the **SELECT** softkey.
4. Press **▲** or **▼** to choose **Auto**, **Line 1**, **Line 2** or **Cell**, then press the **SET** softkey. You hear a confirmation tone.

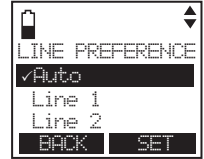
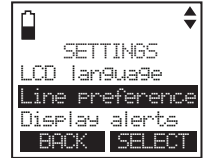
**Display alerts**

The display alerts settings allow you to change the settings of the indicators for missed calls, voicemail, no line alert, answering system alert and directory download failure alert.

To clear the missed call indication:

1. Press the **MENU** softkey in idle mode to enter the main menu.
2. Press **▲** or **▼** to highlight **SETTINGS** and then press the **SELECT** softkey.
3. Press **▲** or **▼** to highlight **Display alerts**, then press the **SELECT** softkey.
4. Press **▲** or **▼** to choose **Line 1**, **Line 2** or **Cell**, then press the **SELECT** softkey.
5. Press the **SELECT** softkey again to choose **Missed calls**. The handset screen displays **Reset missed call indication?** Press the **YES** softkey to confirm and you hear a confirmation tone. When you receive a new missed call, the indicator will turn on again.

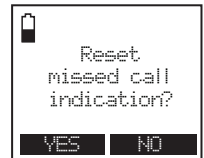
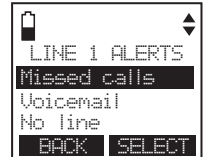
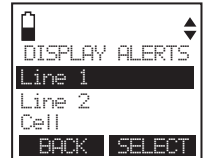

Handset settings

If you subscribe to voicemail service offered by your telephone service provider, **Voicemail** and  appear on the cordless handset and telephone base when you have new voicemail messages. Contact your telephone service provider for more information and assistance about using your voicemail service. This feature only works on the voicemail associated with line 1 or line 2, not the cell line.

After you have listened to all new voicemail messages, the indicators on the handset and telephone base turn off automatically.

Use the clear voicemail feature when the telephone indicates that there is new voicemail but there is none (for example, when you have accessed your voicemail while away from home). Clearing the voicemail waiting indicator only turns off the indicators; it does not delete your voicemail messages. As long as you have new voicemail messages, your telephone service provider continues to send signals that turn on the indicators.

To clear the voicemail indication manually:

1. Press the **MENU** softkey on the handset in idle mode to enter the main menu.
2. Press **▲** or **▼** to scroll to **SETTINGS**, then press the **SELECT** softkey.
3. Press **▲** or **▼** to scroll to **Display alerts**, then press the **SELECT** softkey.
4. Press **▲** or **▼** to choose **Line 1** or **Line 2**, then press the **SELECT** softkey.
5. Press **▲** or **▼** to highlight **Voicemail**, then press the **SELECT** softkey.
6. The screen shows **Reset voicemail indication?** Press the **YES** softkey to turn the voicemail indication off. You hear a confirmation tone.

NOTES:

- Your telephone service provider might alert you to new voicemail messages with a stutter (broken) dial tone. Contact your telephone service provider for more details.
- For more information about the difference between your answering system and voicemail, see page 117.

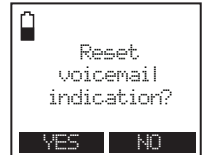
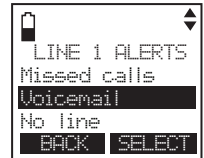
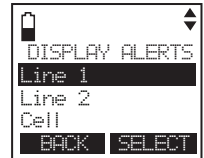
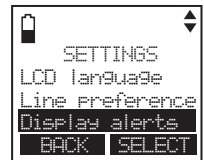

Handset settings

If a working telephone line is not plugged into line 1 or line 2, a **NO LINE** alert will display next to the corresponding line.

To turn the line alert indicator on or off:

1. Press the **MENU** softkey on the handset in idle mode to enter the main menu.
2. Press **▲** or **▼** to scroll to **SETTINGS**, then press the **SELECT** softkey.
3. Press **▲** or **▼** to scroll to **Display alerts**, then press the **SELECT** softkey.
4. Press **▲** or **▼** to choose **Line 1** or **Line 2**, then press the **SELECT** softkey.
5. Press **▲** or **▼** to highlight **No line**, then press the **SELECT** softkey.
6. Press **▲** or **▼** to select **On** or **Off**, then press the **SET** softkey. You hear a confirmation tone.

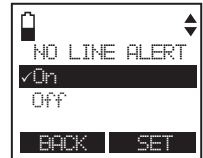
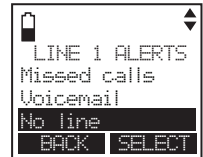

If you turn off the answering system, the cordless handset displays **Ans sys off** to alert you. If you do not want this message to display, you may turn it off.

To turn the answering system alert indicator on or off:

1. Press the **MENU** softkey on the handset in idle mode to enter the main menu.
2. Press **▲** or **▼** to scroll to **SETTINGS**, then press the **SELECT** softkey.
3. Press **▲** or **▼** to scroll to **Display alerts**, then press the **SELECT** softkey.
4. Press **▲** or **▼** to choose **Line 1** or **Line 2**, then press the **SELECT** softkey.
5. Press **▲** or **▼** to highlight **Ans sys off**, then press the **SELECT** softkey.
6. Press **▲** or **▼** to select **On** or **Off**, then press the **SET** softkey. You hear a confirmation tone.

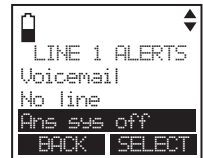

Handset settings

The download failure notification disappears automatically if you view the downloaded directory. You can also turn off the download failure indication on your handset and telephone base manually.

To clear the download failure indication of the cell line:

1. Press the **MENU** softkey on the handset in idle mode to enter the main menu.
2. Press **▲** or **▼** to scroll to **SETTINGS**, then press the **SELECT** softkey.
3. Press **▲** or **▼** to scroll to **Display alerts**, then press the **SELECT** softkey.
4. Press **▲** or **▼** to highlight **Cell**, then press the **SELECT** softkey.
5. Press **▲** or **▼** to highlight **Download fail**, then press the **SELECT** softkey.
6. The handset screen displays **Reset download failure indication?** Press the **YES** softkey to confirm and you hear a confirmation tone.

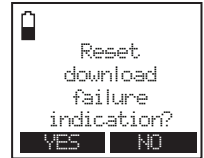
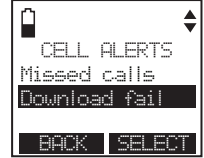

Key tone

The handset is set to beep with each key press. If you turn off the key tone, there are no beeps when you press keys.

To change the setting:

1. Press the **MENU** softkey on the handset in idle mode to enter the main menu.
2. Press **▲** or **▼** to scroll to **SETTINGS**, then press the **SELECT** softkey.
3. Press **▲** or **▼** to scroll to **Key tone**, then press the **SELECT** softkey.
4. Press **▲** or **▼** to select **On** or **Off**, then press the **SET** softkey. You hear a confirmation tone.

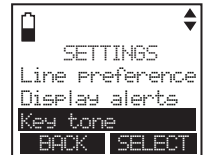

Set date/time

The answering system announces the day and time of each message prior to playing it. If you subscribe to caller ID service, the day, month and time are set automatically with each incoming call. If you do not want to set the date/time automatically with the caller ID information, turn this feature off (see **Use caller ID to automatically set date and time** on page 38).

After handset registration or a power failure, the handset will prompt you to set the date and time (see page 11).

To set the date and time manually:

1. Press the **MENU** softkey on the handset in idle mode to enter the main menu.
2. Press **▲** or **▼** to highlight **SETTINGS**, then press the **SELECT** softkey.
3. Press **▲** or **▼** to highlight **Set date/time**, then press the **SELECT** softkey.
4. Press the **SELECT** softkey to select **Date/time**.
5. Press **▲** or **▼** to select the month and then press the **SET** softkey to confirm, or enter the correct number using the dialing keys.
6. Press **▲** or **▼** to select the day and then press the **SET** softkey to confirm, or enter the correct number using the dialing keys.
7. Press **▲** or **▼** to select the year or enter the correct number using the dialing keys, then press the **SET** softkey.
8. Press **▲** or **▼** to select the hour and then press the **SET** softkey to confirm, or enter the correct number using the dialing keys.
9. Press **▲** or **▼** to select the minute and then press the **SET** softkey to confirm, or enter the correct number using the dialing keys.
10. Press **▲** or **▼** to choose **AM** or **PM**, then press the **SET** softkey to confirm. You hear a confirmation tone.



NOTE: If the clock is not set when a message is recorded, the system announces, "Time and day not set," before the message is played.

Handset settings

Use caller ID to automatically set date and time

You can turn this feature on so that the date and time are set automatically by incoming caller ID information.

1. Press the **MENU** softkey on the handset in idle mode to enter the main menu.
2. Press **▲** or **▼** to highlight **SETTINGS**, then press the **SELECT** softkey.
3. Press **▲** or **▼** to highlight **Set date/time**, then press the **SELECT** softkey.
4. Press **▲** or **▼** to select **CID time sync**, then press the **SELECT** softkey.
5. Press **▲** or **▼** to select **On** or **Off**, then press the **SET** softkey to confirm. You hear a confirmation tone.

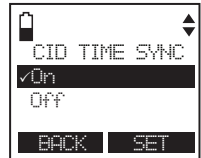
**Dial mode**

The dial mode is preset to tone dialing. If you have pulse (rotary) service, you must change the dial mode to pulse dialing before using the telephone.

To change the setting:

1. Press the **MENU** softkey on the handset in idle mode to enter the main menu.
2. Press **▲** or **▼** to highlight **SETTINGS**, then press the **SELECT** softkey.
3. Press **▲** or **▼** to highlight **Dial mode**, then press the **SELECT** softkey.
4. Press **▲** or **▼** to choose **Tone** or **Pulse**, then press the **SET** softkey to confirm. You hear a confirmation tone.

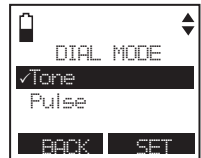
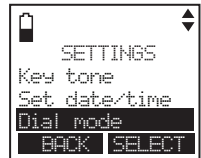

NOTE: While you are on a call in pulse dialing mode, press **TONE** \times to temporarily change to tone dialing mode.

Website

You can use this feature to view the AT&T website address for product support or accessory purchasing.

1. Press the **MENU** softkey on the handset in idle mode to enter the main menu.
2. Press **▲** or **▼** to scroll to **WEBSITE**, then press the **SELECT** softkey. The handset screen shows the AT&T website address.
3. Press the **OK** softkey to exit.



Handset settings

Home area code

If you dial seven digits to make a local call (area code not required), enter your area code into the telephone as the home area code. When you receive a call from within your home area code, the caller ID history only displays the seven digits of the telephone number.

This feature makes it easy for you to place a call from the caller ID history. If you dial 10 digits to make a local phone call, do not use this home area code feature. If you do, you cannot place local calls from your caller ID history, as they will have only seven digits.

To set the home area code:

1. Press the **MENU** softkey on the handset in idle mode to enter the main menu.
2. Press **▲** or **▼** to highlight **DIRECTORY**, then press the **SELECT** softkey.
3. Press the **SELECT** softkey to choose **Home**.
4. Press **▲** or **▼** to highlight **Home area code**, then press the **SELECT** softkey.
5. Use the dialing keys to enter the desired home area code.
 - Press **OFF/CLEAR** to erase a digit.
 - Press **▲** to move the cursor to the right or **▼** to the left.
6. Press the **SET** softkey to confirm. You hear a confirmation tone.

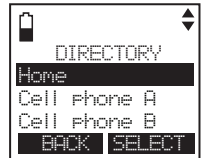

NOTE: If, in the future, your telephone service provider requires you to dial 10 digits to make a local call (area code + telephone number), or, if you move to a location that requires it, delete your home area code following the steps above. After you have deleted the home area code, ___ appears on the handset.

Cell area code

If you have downloaded a directory from your cell phone, you may need to set your cell area code in order to dial a number from your downloaded directory correctly.

Most cell phone entries are stored in a 10-digit format. If all of your cell phone entries are stored this way, you do not need to program your cell area code.

If your cell phone stores entries in a 7-digit format, we recommend that you program your cell area code so that your 7-digit directory entries can be dialed correctly using your land lines.

To set the cell area code:

1. Press the **MENU** softkey on the handset in idle mode to enter the main menu.
2. Press **▲** or **▼** to highlight **DIRECTORY**, then press the **SELECT** softkey.
3. Press **▲** or **▼** to highlight a desired downloaded directory, then press the **SELECT** softkey.
4. Press **▲** or **▼** to highlight **Cell area code**, then press the **SELECT** softkey.
5. Use the dialing keys to enter the desired cell area code.
 - Press **OFF/CLEAR** to erase a digit.
 - Press **▲** to move the cursor to the right or **▼** to the left.
6. Press the **SET** softkey to confirm. You hear a confirmation tone.

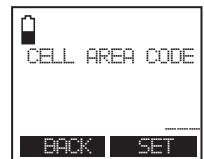
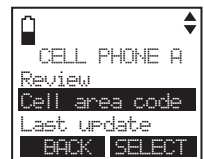
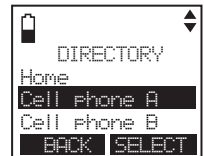

i NOTE: If, in the future, your telephone service provider requires you to dial 10 digits to make a local call (area code + telephone number), or, if you move to a location that requires it, delete your cell area code following the steps above. After you have deleted the cell area code, ___ appears on the handset.

Telephone base settings

Ringer volume

You can select the ringer volume for incoming calls on line 1 or line 2 and the cell line.

To adjust the telephone base ringer volume:

1. Press the **MENU** softkey on the telephone base in idle mode to enter the main menu.
2. Press **▲DIR**, **▼CID**, **▲/DELETE** or **▼/REC** to highlight **Ringers**, then press the **SELECT** softkey.
3. Press the **SELECT** softkey to choose **Ringer volume**.
4. Press **▲DIR**, **▼CID**, **▲/DELETE** or **▼/REC** to select **All lines**, **Line 1**, **Line 2**, **Cell A** or **Cell B**, then press the **SELECT** softkey to confirm.
5. Press **▲DIR**, **▼CID**, **▲/DELETE** or **▼/REC** to adjust the ringer volume. A sample of each ringer volume plays as you scroll through the choices.



-OR-

Press the **OFF** softkey to turn off the ringer. The telephone base displays **Ringer mute**.

6. Press the **SET** softkey to confirm. You hear a confirmation tone.

-OR-

1. Press **▼ VOLUME ▲** to set the ringer volume while the telephone base is in idle mode to set the ringer volume for all lines.
2. Press the **SET** softkey to confirm and you hear a confirmation tone.

-OR-

Press the **OFF** softkey to silence the ringer volume.

**i NOTES:**

- Changing the telephone base ringer volume does not affect the handset ringer volume. For more information on handset ringer volume, see page 31.
- When the ringer volume of line 1 or line 2 is set to off, the telephone base displays **Ringer off** for the corresponding line. When the ringer volume of **Cell A** or **Cell B** is set to off, the telephone base displays **Ringer A off** or **Ringer B off** respectively. When the ringer volume of all cell calls is set to off, the telephone base displays **Ringers off**.

Telephone base settings

Ringer tone

You can select the ringer tones for incoming calls on line 1, line 2 and the cell line.

To select a ringer tone:

1. Press the **MENU** softkey on the telephone base in idle mode to enter the main menu.
2. Press **▲DIR**, **▼CID**, **▲/DELETE** or **▼/REC** to highlight **Ringers**, then press the **SELECT** softkey.
3. Press **▲DIR**, **▼CID**, **▲/DELETE** or **▼/REC** to highlight **Ringer tone**, then press the **SELECT** softkey.
4. Press **▲DIR**, **▼CID**, **▲/DELETE** or **▼/REC** to select **All lines**, **Line 1**, **Line 2**, **Cell A** or **Cell B**, then press the **SELECT** softkey to confirm.
5. Press **▲DIR**, **▼CID**, **▲/DELETE** or **▼/REC** to select a ringer tone. A sample of each ringer tone plays as you scroll through the choices.
6. Press the **SET** softkey to confirm. You hear a confirmation tone.



iNOTE: If you turn off the ringer volume, you do not hear ringer tone samples.

LCD language

You can select **English**, **Français** or **Español** to be used for all screen displays.

To select a language:

1. Press the **MENU** softkey on the telephone base in idle mode to enter the main menu.
2. Press **▲DIR**, **▼CID**, **▲/DELETE** or **▼/REC** to highlight **Settings**, then press the **SELECT** softkey.
3. Press the **SELECT** softkey to select **LCD language**.
4. Press **▲DIR**, **▼CID**, **▲/DELETE** or **▼/REC** to choose **English**, **Français** or **Español**, then press the **SET** softkey. You hear a confirmation tone.



Telephone base settings

Line preference

The line preference setting determines the default line for the corded phone and speakerphone on the telephone base for outgoing calls. You can select **Auto**, **Line 1**, **Line 2** or **Cell** for your call. The **Cell** option will only be available if you have a cell phone paired to the base.

To select a line preference:

1. Press the **MENU** softkey in idle mode to enter the main menu.
2. Press **▲/DIR**, **▼/CID**, **▲/DELETE** or **▼/REC** to highlight **Settings**, then press the **SELECT** softkey.
3. Press **▲/DIR**, **▼/CID**, **▲/DELETE** or **▼/REC** to highlight **Line preference**, then press the **SELECT** softkey.
4. Press **▲/DIR**, **▼/CID**, **▲/DELETE** or **▼/REC** to choose **Auto**, **Line 1**, **Line 2** or **Cell**, then press the **SET** softkey. You hear a confirmation tone.

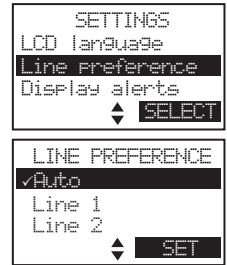
**Display alerts**

The display alerts settings allow you to change the settings of the indicators for missed calls, voicemail, no line alert and download failure notification.

To clear the missed call indication:

1. Press the **MENU** softkey in idle mode.
2. Press **▲/DIR**, **▼/CID**, **▲/DELETE** or **▼/REC** to highlight **Settings** and then press the **SELECT** softkey.
3. Press **▲/DIR**, **▼/CID**, **▲/DELETE** or **▼/REC** to highlight **Display alerts**, then press the **SELECT** softkey.
4. Press **▲/DIR**, **▼/CID**, **▲/DELETE** or **▼/REC** to choose **Line 1**, **Line 2** or **Cell**, then press the **SELECT** softkey.
5. Press the **SELECT** softkey to choose **Missed calls**. The telephone base displays **Reset missed call indication?** Press the **YES** softkey to confirm and you hear a confirmation tone. When you receive a new missed call, the indicator will turn on again.

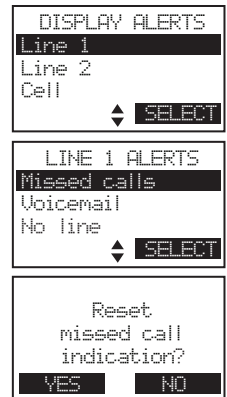

Telephone base settings

If you subscribe to voicemail service offered by your telephone service provider, **Voicemail** and  appear on the cordless handset and telephone base when you have new voicemail messages. Contact your telephone service provider for more information and assistance about using your voicemail service. This feature only works on the voicemail associated with line 1 or line 2, not the cell line.

After you have listened to all new voicemail messages, the indicators on the handset and telephone base turn off automatically.

Use the clear voicemail feature when the telephone indicates that there is new voicemail but there is none (for example, when you have accessed your voicemail while away from home). Clearing the voicemail waiting indicator only turns off the indicators; it does not delete your voicemail messages. As long as you have new voicemail messages, your telephone service provider continues to send signals that turn on the indicators.

To clear the voicemail indication manually:

1. Press the **MENU** softkey on the telephone base in idle mode to enter the main menu.
2. Press **▲DIR**, **▼CID**, **▲/DELETE** or **▼/REC** to scroll to **Settings**, then press the **SELECT** softkey.
3. Press **▲DIR**, **▼CID**, **▲/DELETE** or **▼/REC** to scroll to **Display alerts**, then press the **SELECT** softkey.
4. Press **▲DIR**, **▼CID**, **▲/DELETE** or **▼/REC** to choose **Line 1** or **Line 2**, then press the **SELECT** softkey.
5. Press **▲DIR**, **▼CID**, **▲/DELETE** or **▼/REC** to scroll to **Voicemail**, then press the **SELECT** softkey.
6. The screen shows **Reset voicemail indication?** Press the **YES** softkey to turn the voicemail indication off. You hear a confirmation tone.

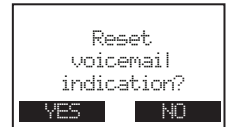
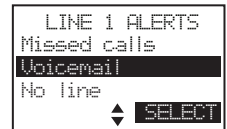

NOTES:

- Your telephone service provider might alert you to new voicemail messages with a stutter (broken) dial tone. Contact your telephone service provider for more details.
- For more information about the difference between your answering system and voicemail, see page 117.

Telephone base settings

If a working telephone line is not plugged into line 1 or line 2, a **NO LINE** alert will display next to the corresponding line.

To turn the line alert indicator on or off:

1. Press the **MENU** softkey on the telephone base in idle mode to enter the main menu.
2. Press **▲DIR**, **▼CID**, **▲/DELETE** or **▼/REC** to scroll to **Settings**, then press the **SELECT** softkey.
3. Press **▲DIR**, **▼CID**, **▲/DELETE** or **▼/REC** to scroll to **Display alerts**, then press the **SELECT** softkey.
4. Press **▲DIR**, **▼CID**, **▲/DELETE** or **▼/REC** to choose **Line 1** or **Line 2**, then press the **SELECT** softkey.
5. Press **▲DIR**, **▼CID**, **▲/DELETE** or **▼/REC** to highlight **No line**, then press the **SELECT** softkey.
6. Press **▲DIR**, **▼CID**, **▲/DELETE** or **▼/REC** to select **On** or **Off**, then press the **SET** softkey. You hear a confirmation tone.

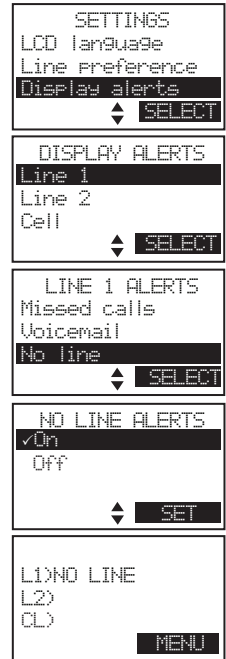

The download failure notification disappears automatically if you view the downloaded directory. You can also turn off the download failure indication on your handset and telephone base manually.

To clear the download failure indication of the cell line:

1. Press the **MENU** softkey on the telephone base in idle mode to enter the main menu.
2. Press **▲DIR**, **▼CID**, **▲/DELETE** or **▼/REC** to scroll to **Settings**, then press the **SELECT** softkey.
3. Press **▲DIR**, **▼CID**, **▲/DELETE** or **▼/REC** to scroll to **Display alerts**, then press the **SELECT** softkey.
4. Press **▲DIR**, **▼CID**, **▲/DELETE** or **▼/REC** to highlight **Cell**, then press the **SELECT** softkey.
5. Press **▲DIR**, **▼CID**, **▲/DELETE** or **▼/REC** to highlight **Download fail**, then press the **SELECT** softkey.
6. The telephone base displays **Reset download failure indication?** Press the **YES** softkey to confirm and you hear a confirmation tone.

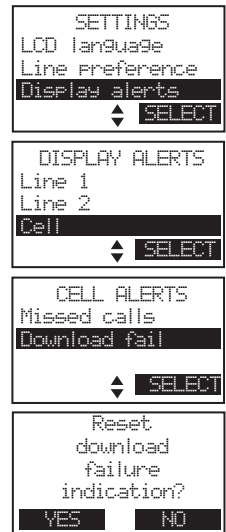

Telephone base settings

Key tone

The telephone base is set to beep with each key press. If you turn off the key tone, there are no beeps when you press keys.

To change the setting:

1. Press the **MENU** softkey on the telephone base in idle mode to enter the main menu.
2. Press **▲DIR**, **▼CID**, **▲/DELETE** or **▼/REC** to highlight **Settings**, then press the **SELECT** softkey.
3. Press **▲DIR**, **▼CID**, **▲/DELETE** or **▼/REC** to highlight **Key tone**, then press the **SELECT** softkey.
4. Press **▲DIR**, **▼CID**, **▲/DELETE** or **▼/REC** to select **On** or **Off**, then press the **SET** softkey. You hear a confirmation tone.

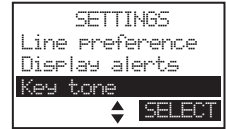

Set date/time

The answering system announces the day and time of each message prior to playing it. If you subscribe to caller ID service, the day, month and time are set automatically with each incoming call. Before using the answering system, set the date and time as follows.

To set the date and time manually:

1. Press the **MENU** softkey on the telephone base in idle mode to enter the main menu.
2. Press **▲DIR**, **▼CID**, **▲/DELETE** or **▼/REC** to highlight **Settings**, then press the **SELECT** softkey.
3. Press **▲DIR**, **▼CID**, **▲/DELETE** or **▼/REC** to highlight **Set date/time**, then press the **SELECT** softkey.
4. Press the **SELECT** softkey to select **Date/time**.
5. Press **▲DIR**, **▼CID**, **▲/DELETE** or **▼/REC** to select the month and then press the **SET** softkey to confirm, or enter the correct number using the dialing keys.
6. Press **▲DIR**, **▼CID**, **▲/DELETE** or **▼/REC** to select the day and then press the **SET** softkey to confirm, or enter the correct number using the dialing keys.
7. Press **▲DIR**, **▼CID**, **▲/DELETE** or **▼/REC** to select the year or enter the correct number using the dialing keys then press the **SET** softkey.
8. Press **▲DIR**, **▼CID**, **▲/DELETE** or **▼/REC** to select the hour and then press the **SET** softkey to confirm, or enter the correct number using the dialing keys.
9. Press **▲DIR**, **▼CID**, **▲/DELETE** or **▼/REC** to select the minute and then press the **SET** softkey to confirm, or enter the correct number using the dialing keys.
10. Press **▲DIR**, **▼CID**, **▲/DELETE** or **▼/REC** to choose **AM** or **PM**, then press the **SET** softkey to confirm. You hear a confirmation tone.



NOTE: If the clock is not set when a message is recorded, the system announces, "Time and day not set," before the message is played.

Telephone base settings

Use caller ID to automatically set date and time

You can turn this feature on so that the date and time are set automatically by incoming caller ID information.

1. Press the **MENU** softkey on the telephone base in idle mode to enter the main menu.
2. Press **▲DIR**, **▼CID**, **▲/DELETE** or **▼/REC** to highlight **Settings**, then press the **SELECT** softkey.
3. Press **▲DIR**, **▼CID**, **▲/DELETE** or **▼/REC** to highlight **Set date/time**, then press the **SELECT** softkey.
4. Press **▲DIR**, **▼CID**, **▲/DELETE** or **▼/REC** to select **CID time sync**, then press the **SELECT** softkey.
5. Press **▲DIR**, **▼CID**, **▲/DELETE** or **▼/REC** to select **On** or **Off**, then press the **SET** softkey to confirm. You hear a confirmation tone.

**Dial mode**

The dial mode is preset to tone dialing. If you have pulse (rotary) service, you must change the dial mode to pulse dialing before using the telephone.

To change the setting:

1. Press the **MENU** softkey on the telephone base in idle mode to enter the main menu.
2. Press **▲DIR**, **▼CID**, **▲/DELETE** or **▼/REC** to highlight **Settings**, then press the **SELECT** softkey.
3. Press **▲DIR**, **▼CID**, **▲/DELETE** or **▼/REC** to highlight **Dial mode**, then press the **SELECT** softkey.
4. Press **▲DIR**, **▼CID**, **▲/DELETE** or **▼/REC** to choose **Tone** or **Pulse**, then press the **SET** softkey to confirm. You hear a confirmation tone.



i NOTE: While you are on a call in pulse dialing mode, press **TONE** \times to temporarily change to tone dialing mode.

Telephone base settings

Website

You can use this feature to view the AT&T website address for product support or accessory purchasing.

1. Press the **MENU** softkey on the telephone base in idle mode to enter the main menu.
2. Press **▲DIR**, **▼CID**, **▲/DELETE** or **▼/REC** to scroll to **Website**, then press the **SELECT** softkey. The telephone base screen shows the AT&T website address.
3. Press the **OK** softkey to exit.

**Home area code**

If you dial seven digits to make a local call (area code not required), enter your area code into the telephone as the home area code. When you receive a call from within your home area code, the caller ID history only displays the seven digits of the telephone number.

This feature makes it easy for you to place a call from the caller ID history. If you dial 10 digits to make a local phone call, do not use this home area code feature. If you do, you cannot place local calls from your caller ID history, as they will have only seven digits.

To set the home area code:

1. Press the **MENU** softkey on the telephone base in idle mode to enter the main menu.
2. Press **▲DIR**, **▼CID**, **▲/DELETE** or **▼/REC** to highlight **Directory**, then press the **SELECT** softkey.
3. Press the **SELECT** softkey to choose **Home**.
4. Press **▲DIR**, **▼CID**, **▲/DELETE** or **▼/REC** to highlight **Home area code**, then press the **SELECT** softkey.
5. Use the dialing keys to enter the desired home area code.
 - Press **CANCEL** to erase a digit.
 - Press **▲DIR** or **►/SKIP** to move the cursor to the right. Press **▼CID** or **◄/REPEAT** to move to the left.
6. Press the **SET** softkey to confirm. You hear a confirmation tone.



iNOTE: If, in the future, your telephone service provider requires you to dial 10 digits to make a local call (area code + telephone number), or, if you move to a location that requires it, delete your home area code you have already programmed following the steps above. After you have deleted the home area code, **_ _ _** appears on the telephone base.

Cell area code

If you have downloaded a directory from your cell phone, you may need to set your cell area code in order to dial a number from your downloaded directory correctly.

Most cell phone entries are stored in a 10-digit format. If all of your cell phone entries are stored this way, you do not need to program your cell area code.

If your cell phone stores entries in a 7-digit format, we recommend that you program your cell area code so that your 7-digit directory entries can be dialed correctly using your land lines.

To set the cell area code:

1. Press the **MENU** softkey on the telephone base in idle mode to enter the main menu.
2. Press **▲/DIR**, **▼/CID**, **▲/DELETE** or **▼/REC** to highlight **Directory**, then press the **SELECT** softkey.
3. Press **▲/DIR**, **▼/CID**, **▲/DELETE** or **▼/REC** to highlight a desired downloaded directory, then press the **SELECT** softkey.
4. Press **▲/DIR**, **▼/CID**, **▲/DELETE** or **▼/REC** to highlight **Cell area code**, then press the **SELECT** softkey.
5. Use the dialing keys to enter the desired cell area code.
 - Press **CANCEL** to erase a digit.
 - Press **▲/DIR** or **▶/SKIP** to move the cursor to the right. Press **▼/CID** or **◀/REPEAT** to move to the left.
6. Press the **SET** softkey to confirm. You hear a confirmation tone.



NOTE: If, in the future, your telephone service provider requires you to dial 10 digits to make a local call (area code + telephone number), or, if you move to a location that requires it, delete your cell area code you have already programmed following the steps above. After you have deleted the cell area code, ___ appears on the telephone base.

Answering system settings

Announcement

An announcement is the greeting callers hear when calls are answered by the answering system.

The telephone is preset with a greeting that answers calls with *"Hello, please leave a message after the tone."* You can use this preset announcement, or replace it with your own.

Line 1 and line 2 each have two separate announcements, **Annc A** and **Annc B**, stored in the answering system and can be scheduled by time.

If you set the announcement mode to **Annc A only**, the answering system only plays **Annc A** for all calls. If you set the announcement mode to **Annc B only**, the answering system only plays **Annc B** for all calls. If you set the announcement mode to **A & B schedule**, the answering system announces either **Annc A** or **Annc B**, depending on the time of the incoming call. By default, **Annc A** plays between 9:00 AM and 5:59 PM, and **Annc B** plays between 6:00 PM and 8:59 AM.

To set the announcement mode:

Using a cordless handset:

1. Press the **MENU** softkey on the handset in idle mode to enter the main menu.
2. Press **▲** or **▼** to scroll to **ANSWERING SYS**, then press the **SELECT** softkey.
3. Press **▲** or **▼** to choose **Mailbox 1** or **Mailbox 2**, then press the **SELECT** softkey.
4. Press the **SELECT** softkey again to select **Announcement**.
5. Press **▲** or **▼** to highlight **Annc mode**, then press the **SELECT** softkey.
6. Press **▲** or **▼** to choose **Annc A only**, **Annc B only** or **A & B schedule**, then press the **SET** softkey to confirm.

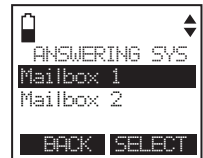

Answering system settings

Using the telephone base:

1. Press the **MENU** softkey on the telephone base in idle mode to enter the main menu.
2. Press **▲DIR**, **▼CID**, **▲/DELETE** or **▼/REC** to highlight **Answering sys**, then press the **SELECT** softkey.
3. Press **▲DIR**, **▼CID**, **▲/DELETE** or **▼/REC** to choose **Mailbox 1** or **Mailbox 2**, then press the **SELECT** softkey.
4. Press the **SELECT** softkey again to select **Announcement**.
5. Press **▲DIR**, **▼CID**, **▲/DELETE** or **▼/REC** to highlight **Annc mode** and then press the **SELECT** softkey.
6. Press **▲DIR**, **▼CID**, **▲/DELETE** or **▼/REC** to choose **Annc A only**, **Annc B only** or **A & B schedule**, then press the **SET** softkey to confirm.

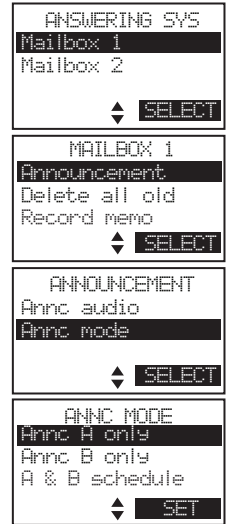

Answering system settings

To set the time schedules of the announcements:**Using a cordless handset:**

1. Press the **MENU** softkey on the handset in idle mode to enter the main menu.
2. Press **▲** or **▼** to scroll to **ANSWERING SYS**, then press the **SELECT** softkey.
3. Press **▲** or **▼** to choose **Mailbox 1** or **Mailbox 2**, then press the **SELECT** softkey.
4. Press the **SELECT** softkey again to choose **Announcement**.
5. Press **▲** or **▼** to highlight **Ann mode**, then press the **SELECT** softkey.
6. Press **▲** or **▼** to highlight **A & B schedule**, then press the **TIMES** softkey.
7. The handset displays **ANNC A BEGINS**. Press **▲** or **▼**, or use the dialing keys to set the starting time for **Ann c A**. Press the **SET** softkey to confirm.
8. The handset displays **ANNC B BEGINS**. Press **▲** or **▼**, or use the dialing keys to set the starting time for **Ann c B**. Press the **SET** softkey to confirm.
9. The handset displays the time schedules set in the telephone system. Press the **OK** softkey to confirm.

NOTES:

- If the clock is not set, the cordless handset displays **To use A & B schedule, system clock must be set**. Set the date and time (page 37) before you set the announcement mode.
- If the answering system is off when you attempt to record an outgoing announcement, the answering system automatically turns on. If the memory is full, the answering system displays **Calls will not be answered. Mailbox X full**.

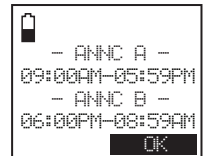
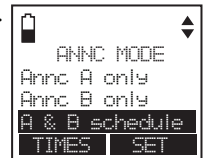
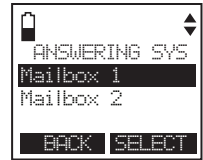

Answering system settings

Using the telephone base:

1. Press the **MENU** softkey on the telephone base in idle mode to enter the main menu.
2. Press **▲DIR**, **▼CID**, **▲/DELETE** or **▼/REC** to highlight **Answering sys**, then press the **SELECT** softkey.
3. Press **▲DIR**, **▼CID**, **▲/DELETE** or **▼/REC** to choose **Mailbox 1** or **Mailbox 2**, then press the **SELECT** softkey.
4. Press the **SELECT** softkey again to choose **Announcement**.
5. Press **▲DIR**, **▼CID**, **▲/DELETE** or **▼/REC** to highlight **Ann mode** and then press the **SELECT** softkey.
6. Press **▲DIR**, **▼CID**, **▲/DELETE** or **▼/REC** to highlight to **A & B schedule**, then press the **TIMES** softkey.
7. The telephone base displays **ANNC A BEGINS**. Press **▲DIR**, **▼CID**, **▲/DELETE** or **▼/REC**, or use the dialing keys to set the answering system time for **Ann A**. Press the **SET** softkey to confirm.
8. The telephone base displays **ANNC B BEGINS**. Press **▲DIR**, **▼CID**, **▲/DELETE** or **▼/REC**, or use the dialing keys to set the answering system time for **Ann B**. Press the **SET** softkey to confirm.
9. The telephone base displays the time schedules set in the telephone system. Press the **OK** softkey to confirm.

```

ANNOUNCEMENT
Ann mode
Ann mode
          ▲▼ SELECT
  
```

```

ANNC MODE
Ann A only
Ann B only
A & B schedule
          ▲▼ SET
  
```

```

ANNC A BEGINS
09:00 AM
          SET
  
```

```

ANNC B BEGINS
06:00 PM
          ▲▼ SET
  
```

```

- ANNC A -
09:00AM - 05:59PM
- ANNC B -
06:00PM - 08:59AM
          OK
  
```

NOTES:

- If the clock is not set, the telephone base displays **To use A & B schedule, system clock must be set**. Set the date and time (page 47) before you set the announcement mode.
- If the answering system is off when you attempt to record an outgoing announcement, the answering system automatically turns on. If the memory is full, the answering system displays **Calls will not be answered. Mailbox X full**.

Answering system settings

To play your announcement:**Using a cordless handset:**

1. Press the **MENU** softkey on the handset in idle mode to enter the main menu.
2. Press **▲** or **▼** to scroll to **ANSWERING SYS**, then press the **SELECT** softkey.
3. Press **▲** or **▼** to choose **Mailbox 1** or **Mailbox 2**, then press the **SELECT** softkey.
4. Press the **SELECT** softkey again to choose **Announcement**.
5. Press the **SELECT** softkey again to choose **Annc audio**.
6. Press **▲** or **▼** to choose **Annc A** or **Annc B**, then press the **PLAY** softkey. During announcement playback, you may press the **STOP** softkey to stop.

**Using the telephone base:**

1. Press the **MENU** softkey on the telephone base in idle mode to enter the main menu.
2. Press **▲DIR**, **▼CID**, **▲/DELETE** or **▼/REC** to highlight **Answering sys**, then press the **SELECT** softkey.
3. Press **▲DIR**, **▼CID**, **▲/DELETE** or **▼/REC** to choose **Mailbox 1** or **Mailbox 2**, then press the **SELECT** softkey.
4. Press the **SELECT** softkey again to choose **Announcement**.
5. Press the **SELECT** softkey again to choose **Annc audio**.
6. Press **▲DIR**, **▼CID**, **▲/DELETE** or **▼/REC** to choose **Annc A** or **Annc B**, then press the **PLAY** softkey. During announcement playback, you may press the **STOP** softkey to stop.

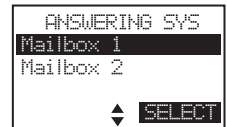

Answering system settings

To record your announcement:**Using a cordless handset:**

1. Press the **MENU** softkey on the handset in idle mode to enter the main menu.
2. Press **▲** or **▼** to scroll to **ANSWERING SYS**, then press the **SELECT** softkey.
3. Press **▲** or **▼** to choose **Mailbox 1** or **Mailbox 2**, then press the **SELECT** softkey.
4. Press the **SELECT** softkey again to select **Announcement**.
5. Press the **SELECT** softkey again to choose **Annc audio**.
6. Press **▲** or **▼** to choose **Annc A** or **Annc B**, then press the **RECORD** softkey.
7. The handset announces, "Record after the tone. Press **STOP** when you are done." After the tone, speak towards the microphone of the handset.
8. Press the **STOP** softkey when you finish recording.
9. The handset plays the recorded announcement and displays **Announcement playback**. Press the **STOP** softkey to stop the playback.

Using the telephone base:

1. Press the **MENU** softkey on the telephone base in idle mode to enter the main menu.
2. Press **▲DIR**, **▼CID**, **▲/DELETE** or **▼/REC** to highlight **Answering sys**, then press the **SELECT** softkey.
3. Press **▲DIR**, **▼CID**, **▲/DELETE** or **▼/REC** to choose **Mailbox 1** or **Mailbox 2**, then press the **SELECT** softkey.
4. Press the **SELECT** softkey again to choose **Announcement**.
5. Press the **SELECT** softkey again to choose **Annc audio**.
6. Press **▲DIR**, **▼CID**, **▲/DELETE** or **▼/REC** to choose **Annc A** or **Annc B**, then press the **RECORD** softkey.
7. The telephone base announces, "Record after the tone. Press **STOP** when you are done." After the tone, speak towards the microphone of the telephone base.
8. Press the **STOP** softkey when you finish recording.
9. The telephone base plays the recorded announcement and displays **Announcement playback**. Press the **STOP** softkey to stop the playback.

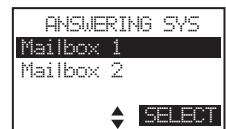
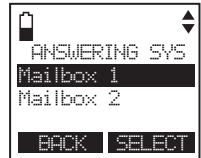

Answering system settings

-OR-

1. Press **▼/REC** on the telephone base in idle mode.
2. Press **▲/DIR**, **▼/CID**, **▲/DELETE** or **▼/REC** to highlight **Announcement**, then press the **SELECT** softkey.
3. Press **▲/DIR**, **▼/CID**, **▲/DELETE** or **▼/REC** to highlight **Mailbox 1** or **Mailbox 2**, then press the **SELECT** softkey.
4. If the announcement mode is set to **Annnc A only**, the telephone base displays **Current mode is Annnc A only. Please select audio to record**. Press the **Annnc A** softkey or the **Annnc B** softkey to record an announcement.



-OR-

If the announcement mode is set to **Annnc B only**, the telephone base displays **Current mode is Annnc B only. Please select audio to record**. Press the **Annnc A** softkey or the **Annnc B** softkey to record an announcement.

-OR-

If the announcement mode is set to **A & B schedule**, the telephone base displays **Current mode is A & B schedule. Please select audio to record**. Press the **Annnc A** softkey or the **Annnc B** softkey to record an announcement.

5. The telephone base announces, "Record after the tone. Press **STOP** when you are done." After the tone, speak towards the microphone of the telephone base. Press the **STOP** softkey when you finish recording.
6. The telephone base plays the recorded announcement and displays **Announcement playback**. Press the **STOP** softkey to stop the playback or press the **RETRY** softkey to record the announcement again.



iNOTES:

- Your announcement can be up to 90 seconds in length.
- Announcements shorter than two seconds are not recorded.
- If the announcement you select to record does not match with the current announcement mode, the telephone base displays **Selected audio does not match current mode. Proceed?** Press the **YES** softkey to continue.

Answering system settings

To delete your announcement:

Using a cordless handset:

1. Press the **MENU** softkey on the handset in idle mode to enter the main menu.
2. Press **▲** or **▼** to scroll to **ANSWERING SYS**, then press the **SELECT** softkey.
3. Press **▲** or **▼** to choose **Mailbox 1** or **Mailbox 2**, then press the **SELECT** softkey.
4. Press the **SELECT** softkey to choose **Announcement**.
5. Press the **SELECT** softkey again to choose **Annc audio**.
6. Press **▲** or **▼** to choose **Annc A** or **Annc B**, then press the **PLAY** softkey.
7. Press the **DELETE** softkey while the handset is playing the announcement.
8. The handset displays **Reset announcement to default?** Press the **YES** softkey to confirm. You hear a confirmation tone.

Using the telephone base:

1. Press the **MENU** softkey on the telephone base in idle mode to enter the main menu.
2. Press **▲DIR**, **▼CID**, **▲/DELETE** or **▼/REC** to scroll to **Answering sys**, then press the **SELECT** softkey.
3. Press **▲DIR**, **▼CID**, **▲/DELETE** or **▼/REC** to choose **Mailbox 1** or **Mailbox 2**, then press the **SELECT** softkey.
4. Press the **SELECT** softkey to choose **Announcement**.
5. Press the **SELECT** softkey again to choose **Annc audio**.
6. Press **▲DIR**, **▼CID**, **▲/DELETE** or **▼/REC** to choose **Annc A** or **Annc B**, then press the **PLAY** softkey.
7. Press the **DELETE** softkey while the telephone base is playing the announcement.
8. The telephone base displays **Reset announcement to default?** Press the **YES** softkey to confirm. You hear a confirmation tone.

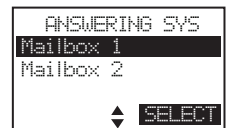
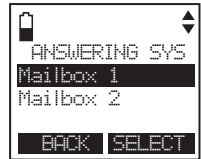

Answering system settings

Answer ON/OFF

If you turn the answering system on, it answers calls and records messages only on line 1 and line 2. If your paired cell phone has voicemail, callers can leave messages with that voicemail service.

When the answering system of line 1 or line 2 is turned on, the respective light on the telephone base turns on.

To turn the answering system on or off:

Using a cordless handset:

1. Press the **MENU** softkey on the handset in idle mode to enter the main menu.
2. Press **▲** or **▼** to scroll to **ANSWERING SYS**, then press the **SELECT** softkey.
3. Press **▲** or **▼** to choose **Mailbox 1** or **Mailbox 2**, then press the **SELECT** softkey.
4. Press **▲** or **▼** to highlight **Answer ON/OFF**, then press the **SELECT** softkey.
5. Press **▲** or **▼** to choose **On** or **Off**, then press the **SET** softkey to confirm. You hear a confirmation tone.

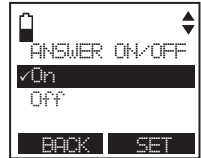
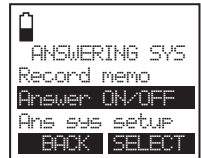
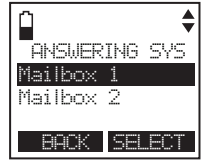

Answering system settings

Using the telephone base:

- Press **ON/OFF LINE 1** or **ON/OFF LINE 2** to turn on the corresponding answering system. The telephone base announces, *"Calls will be answered."* The corresponding light turns on.
- Press **ON/OFF LINE 1** or **ON/OFF LINE 2** to turn off the corresponding answering system. The telephone base announces, *"Calls will not be answered."* The corresponding light turns off.

-OR-

1. Press the **MENU** softkey on the telephone base in idle mode to enter the main menu.
2. Press **▲DIR**, **▼CID**, **▲/DELETE** or **▼/REC** to scroll to **Answering sys**, then press the **SELECT** softkey.
3. Press **▲DIR**, **▼CID**, **▲/DELETE** or **▼/REC** to choose **Mailbox 1** or **Mailbox 2**, then press the **SELECT** softkey.
4. Press **▲DIR**, **▼CID**, **▲/DELETE** or **▼/REC** to highlight **Answer ON/OFF**, then press the **SELECT** softkey.
5. Press **▲DIR**, **▼CID**, **▲/DELETE** or **▼/REC** to choose **On** or **Off**, then press the **SET** softkey to confirm. You hear a confirmation tone.



iNOTES:

- If there is no remaining recording time, the answering system announces, *"Memory is full"* and it turns off and cannot be turned back on.
- If the total recording time is less than three minutes, the answering system announces, *"Less than three minutes to record,"* and your handset and telephone base display **Ans sys low**.
- If the answering system is off, you may press **ON/OFF LINE 1** or **ON/OFF LINE 2** on the telephone base to turn on the corresponding answering system during an incoming call. The corresponding answering system answers the call immediately.

Answering system settings

In the answering system setup menu, you can change the settings for call screening, number of rings, remote access code, message alert tone and recording time.

Call screening

The call screening feature lets you listen to a caller leaving a message at the telephone base. While monitoring an incoming message, you can answer the call by pressing **1 LINE/FLASH**, **2 LINE/FLASH** or **⏪/SPEAKER** on the handset, or pressing **1 LINE**, **2 LINE** or **SPEAKER⏪** on the telephone base, or using the corded handset.

To change the setting:

1. Press the **MENU** softkey on the telephone base in idle mode to enter the main menu.
2. Press **▲/DIR**, **▼/CID**, **▲/DELETE** or **▼/REC** to highlight **Answering sys**, then press the **SELECT** softkey.
3. Press **▲/DIR**, **▼/CID**, **▲/DELETE** or **▼/REC** to choose **Mailbox 1** or **Mailbox 2**, then press the **SELECT** softkey.
4. Press **▲/DIR**, **▼/CID**, **▲/DELETE** or **▼/REC** to highlight **Ans sys setup**, then press the **SELECT** softkey.
5. Press the **SELECT** softkey again to select **Call screening**.
6. Press **▲/DIR**, **▼/CID**, **▲/DELETE** or **▼/REC** to choose **On** or **Off**, then press the **SET** softkey. You hear a confirmation tone.

 **NOTE:** For more information on call screening, see page 119.

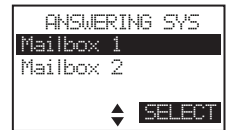

Answering system settings

Number of rings

When the answering system is turned on, it answers all incoming calls on line 1 and line 2 after the number of rings set. You can choose from two, four, or six rings; or toll saver. With toll saver selected, the answering system answers after two rings when you have new messages, and after four rings when you have no new messages. This enables you to check for new messages and avoid paying unnecessary long distance charges if you are calling from out of your local area.

To set the number of rings:

Using a cordless handset:

1. Press the **MENU** softkey on the handset in idle mode to enter the main menu.
2. Press **▲** or **▼** to scroll to **ANSWERING SYS**, then press the **SELECT** softkey.
3. Press **▲** or **▼** to choose **Mailbox 1** or **Mailbox 2**, then press the **SELECT** softkey.
4. Press **▲** or **▼** to highlight **Ans sys setup**, then press the **SELECT** softkey.
5. Press the **SELECT** softkey again to select **# of rings**.
6. Press **▲** or **▼** to choose **6**, **4**, **2** or **Toll saver**, then press the **SET** softkey. You hear a confirmation tone.

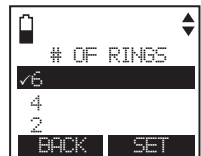
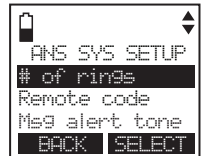
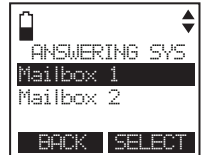

Using the telephone base:

1. Press the **MENU** softkey on the telephone base in idle mode to enter the main menu.
2. Press **▲DIR**, **▼CID**, **▲/DELETE** or **▼/REC** to highlight **Answering sys**, then press the **SELECT** softkey.
3. Press **▲DIR**, **▼CID**, **▲/DELETE** or **▼/REC** to choose **Mailbox 1** or **Mailbox 2**, then press the **SELECT** softkey.
4. Press **▲DIR**, **▼CID**, **▲/DELETE** or **▼/REC** to highlight **Ans sys setup**, then press the **SELECT** softkey.
5. Press **▲DIR**, **▼CID**, **▲/DELETE** or **▼/REC** to highlight **# of rings**, then press the **SELECT** softkey.
6. Press **▲DIR**, **▼CID**, **▲/DELETE** or **▼/REC** to choose **6**, **4**, **2** or **Toll saver**, then press the **SET** softkey. You hear a confirmation tone.



Answering system settings

Remote access code

A two-digit security code is required to access the answering system remotely from any touch-tone telephone. The preset code is **19**. You can change the code to any number from **00** to **99**. Once you set the remote access code, the answering system automatically turns on.

To change the remote code:

Using a cordless handset:

1. Press the **MENU** softkey on the handset in idle mode to enter the main menu.
2. Press **▲** or **▼** to scroll to **ANSWERING SYS**, then press the **SELECT** softkey.
3. Press **▲** or **▼** to choose **Mailbox 1** or **Mailbox 2**, then press the **SELECT** softkey.
4. Press **▲** or **▼** to highlight **Ans sys setup**, then press the **SELECT** softkey.
5. Press **▲** or **▼** to highlight **Remote code**, then press the **SELECT** softkey.
6. Use the dialing keys (**0-9**) to enter a two-digit number from **00-99**.
 - Press **OFF/CLEAR** to erase a digit.
 - Press **▲** to move the cursor to the right or **▼** to the left.
7. Press the **SET** softkey to confirm.

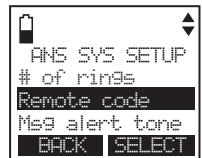
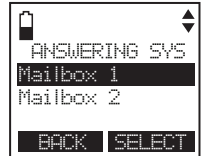

Using the telephone base:

1. Press the **MENU** softkey on the telephone base in idle mode to enter the main menu.
2. Press **▲DIR**, **▼CID**, **▲/DELETE** or **▼/REC** to scroll to **Answering sys**, then press the **SELECT** softkey.
3. Press **▲DIR**, **▼CID**, **▲/DELETE** or **▼/REC** to choose **Mailbox 1** or **Mailbox 2**, then press the **SELECT** softkey.
4. Press **▲DIR**, **▼CID**, **▲/DELETE** or **▼/REC** to highlight **Ans sys setup**, then press the **SELECT** softkey.
5. Press **▲DIR**, **▼CID**, **▲/DELETE** or **▼/REC** to highlight **Remote code**, then press the **SELECT** softkey.
6. Use the dialing keys (**0-9**) to enter a two-digit number from **00-99**.
 - Press **CANCEL** to erase a digit.
 - Press **▲DIR** or **▶/SKIP** to move the cursor to the right. Press **▼CID** or **◀/REPEAT** to move to the left.
7. Press the **SET** softkey to confirm.

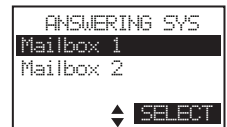

Answering system settings

Message alert tone

When the message alert tone is turned on, the telephone base beeps every 10 seconds to alert you of new messages. The tone stops when all new messages have been reviewed. The default message alert setting is off.

To set the message alert tone on or off:

Using a cordless handset:

1. Press the **MENU** softkey on the handset in idle mode to enter the main menu.
2. Press **▲** or **▼** to scroll to **ANSWERING SYS**, then press the **SELECT** softkey.
3. Press **▲** or **▼** to choose **Mailbox 1** or **Mailbox 2**, then press the **SELECT** softkey.
4. Press **▲** or **▼** to highlight **Ans sys setup**, then press the **SELECT** softkey.
5. Press **▲** or **▼** to highlight **Msg alert tone**, then press the **SELECT** softkey.
6. Press **▲** or **▼** to choose **On** or **Off**.
7. Press the **SET** softkey to confirm. You hear a confirmation tone.

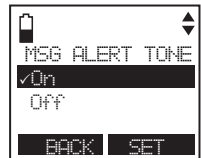
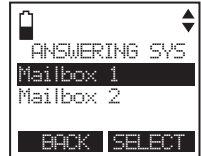

Using the telephone base:

1. Press the **MENU** softkey on the telephone base in idle mode to enter the main menu.
2. Press **▲DIR**, **▼CID**, **▲/DELETE** or **▼/REC** to highlight **Answering sys**, then press the **SELECT** softkey.
3. Press **▲DIR**, **▼CID**, **▲/DELETE** or **▼/REC** to choose **Mailbox 1** or **Mailbox 2**, then press the **SELECT** softkey.
4. Press **▲DIR**, **▼CID**, **▲/DELETE** or **▼/REC** to highlight **Ans sys setup**, then press the **SELECT** softkey.
5. Press **▲DIR**, **▼CID**, **▲/DELETE** or **▼/REC** to highlight **Msg alert tone**, then press the **SELECT** softkey.
6. Press **▲DIR**, **▼CID**, **▲/DELETE** or **▼/REC** to choose **On** or **Off**.
7. Press the **SET** softkey to confirm. You hear a confirmation tone.

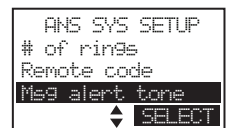

Answering system settings

Recording time

You can set the recording time for each incoming message.

To set the recording time:**Using a cordless handset:**

1. Press the **MENU** softkey on the handset in idle mode to enter the main menu.
2. Press **▲** or **▼** to scroll to **ANSWERING SYS**, then press the **SELECT** softkey.
3. Press **▲** or **▼** to choose **Mailbox 1** or **Mailbox 2**, then press the **SELECT** softkey.
4. Press **▲** or **▼** to scroll to **Ans sys setup**, then press the **SELECT** softkey.
5. Press **▲** or **▼** to scroll to **Recording time**, then press the **SELECT** softkey.
6. Press **▲** or **▼** to choose **3 minutes**, **2 minutes** or **1 minute**, then press the **SET** softkey to confirm. You hear a confirmation tone.

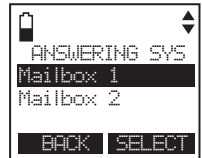
**Using the telephone base:**

1. Press the **MENU** softkey on the telephone base in idle mode to enter the main menu.
2. Press **▲DIR**, **▼CID**, **▲/DELETE** or **▼/REC** to highlight **Answering sys**, then press the **SELECT** softkey.
3. Press **▲DIR**, **▼CID**, **▲/DELETE** or **▼/REC** to choose **Mailbox 1** or **Mailbox 2**, then press the **SELECT** softkey.
4. Press **▲DIR**, **▼CID**, **▼/REC** or **▲/DELETE** to highlight **Ans sys setup**, then press the **SELECT** softkey.
5. Press **▲DIR**, **▼CID**, **▲/DELETE** or **▼/REC** to highlight **Recording time**, then press the **SELECT** softkey.
6. Press **▲DIR**, **▼CID**, **▲/DELETE** or **▼/REC** to choose **3 minutes**, **2 minutes** or **1 minute**, then press the **SET** softkey to confirm. You hear a confirmation tone.

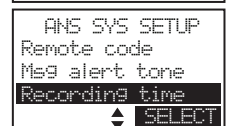
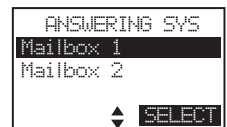

Make, answer and end a call

Make, answer or end a call on line 1 or line 2

Using a cordless handset:

To make a call on line 1 or line 2:

1. Press **1 LINE/FLASH, 2 LINE/FLASH** or **☎/SPEAKER**.
2. Enter the telephone number.

To predial a call on line 1 or line 2:

1. Enter the telephone number.
2. Press **1 LINE/FLASH, 2 LINE/FLASH** or **☎/SPEAKER**.

To answer a call on line 1 or line 2:

- Press **1 LINE/FLASH, 2 LINE/FLASH** or **☎/SPEAKER**.

To end a call on line 1 or line 2:



- Press **OFF/CLEAR** or return the handset to the charger to hang up.

NOTES:



- The screen shows the elapsed time as you talk (in hours, minutes and seconds).
- When predialing (preview numbers before dialing), press **OFF/CLEAR** to backspace and delete; press and hold **REDIAL/PAUSE** to insert a dialing pause (a **p** appears).

Using the telephone base:



To make a call on line 1 or line 2:

1. Lift the corded handset or press **1 LINE, 2 LINE, HEADSET**  or **SPEAKER**  on the telephone base.
2. Enter the telephone number.

To predial a call on line 1 or line 2:

1. Enter the telephone number.
2. Press **1 LINE, 2 LINE, HEADSET**  or **SPEAKER** , or lift the corded handset.

To answer a call on line 1 or line 2:

- Lift the corded handset.
- OR-
- Press the line button of the ringing line.
- OR-
- Press **HEADSET**  or **SPEAKER** .

To end a call on line 1 or line 2 call:

- If you are using the speakerphone, press **SPEAKER** , or the corresponding line button to end the call.
- If you are using the corded handset, return it to the telephone base or press the corresponding line button.

NOTES:

- The screen shows the elapsed time as you talk (in hours, minutes and seconds).
- When predialing (preview numbers before dialing), press **CANCEL** to backspace and delete; press the **PAUSE** softkey to insert a dialing pause (a **p** appears).

Make, answer and end a call

Using a Bluetooth headset:

You can use a Bluetooth headset for calls on line 1 or line 2. Bluetooth wireless technology operates within a short range (up to 30 feet). Keep the headset within 15 feet of the telephone base for optimal performance. See the user's manual of your Bluetooth headset for more information.

To answer a call on line 1 or line 2:



- Press **HEADSET**  on the telephone base or the call key on your headset.

To end a call on line 1 or line 2:

- Press **HEADSET** , the corresponding line button, or the call key on your headset.

If you are on a call on line 1 or line 2 on the telephone base, you can transfer the call to your headset. The telephone base remains active.

To transfer a call from the telephone base to a Bluetooth headset:

- Press **HEADSET** . The telephone base displays **Sending audio to headset**. To transfer the call from the Bluetooth headset back to the telephone base, lift up the corded handset or press **SPEAKER**  on the telephone base and continue speaking.

NOTES:

- If you answer a call using a Bluetooth headset, and you lose the Bluetooth connection or the battery is depleted, the call is lost.
- When you try to use a Bluetooth headset that is not connected to the base, the telephone base displays **Bluetooth headset not connected**. Press the **CONNECT** softkey to connect your headset to the telephone system. Refer to **Pair a headset** on pages 18-19 and **Connect/disconnect an active device** on page 23.
- You cannot transfer a cell call to a Bluetooth headset. If you try to do so, the telephone base displays **Bluetooth headset unavailable during cell call**.

Make, answer and end a call

Call waiting on line 1 or line 2 call

If you subscribe to call waiting service from your telephone service provider, you hear a beep if someone calls while you are already on a call.

- Press the corresponding line button, **1 LINE/FLASH** or **2 LINE/FLASH**, on the handset, or **FLASH** on the telephone base to put your current call on hold and take the new call.
- Press the corresponding line button, **1 LINE/FLASH** or **2 LINE/FLASH**, on the handset, or **FLASH** on the telephone base at any time to switch back and forth between calls.

Make, answer or end a cell call

You can connect a maximum of two Bluetooth enabled cell phones to the telephone base, but only one cell phone can be used on a cell call at a time. The **TL86109** can be used to make or answer calls on the cell phone line.

Using a cordless handset:

To make a cell call:

1. Press  **CELL**, then enter the telephone number.
2. Press the **DIAL** softkey.

To predial a cell call:

- Enter the telephone number, then press  **CELL**.

If you have only one cell phone connected to the telephone base, it is automatically selected to make cell calls. If you have two cell phones connected to the telephone base, the telephone system prompts you to select a cell phone before you make a cell call.

To answer a cell call:

- Press  **CELL**.

To end a cell call:

- Press  **OFF/CLEAR** or put the handset in the charger.

NOTES:

- You can also use your cell phone to answer the call. If you answer with your cell phone, it disconnects from the telephone base.
- If you do not want to answer the call, press the **REJECT** softkey.
- When you try to make a cell call but your cell phone is not connected to the base, the cordless handset displays **Cellular phone not connected**. Press the **CONNECT** softkey to connect your cell phone to the telephone system. Refer to **Pair a cell phone** on pages 16-17 and **Connect/disconnect an active device** on page 23.

Make, answer and end a call

Using the telephone base:

To make a cell call:

1. Press **CELLULAR** (📶), then enter the telephone number.
2. Press the **DIAL** softkey.

To predial a cell call:

- Enter the telephone number, then press **CELLULAR** (📶).

If you have only one cell phone connected to the telephone base, it is automatically selected to make cell calls. If you have two cell phones connected to the telephone base, the telephone system prompts you to select a cell phone before you make a cell call.

To answer a cell call:

- Press **CELLULAR** (📶).

To end a cell call:

- Press **CELLULAR** (📶), **SPEAKER** (🔊), or return the corded handset to the telephone base.

NOTES:

- You can also use your cell phone to answer the call. If you answer with your cell phone, it disconnects from the telephone base.
- If you do not want to answer the call, press the **REJECT** softkey.
- When you try to make a cell call but your cell phone is not connected to the base, the telephone base displays **Cellular phone not connected**. Press the **CONNECT** softkey to connect your cell phone to the telephone system. Refer to **Pair a cell phone** on pages 16-17 and **Connect/disconnect an active device** on page 23.

Call waiting on the cell line

If you subscribe to call waiting service from your cell phone service provider, you hear a beep if someone calls while you are already on a call.

Using a cordless handset:

- Press the **SWAP** softkey on the handset. The original call is put on hold and you can take the new call.
- Press the **OPTION** softkey on the handset. Press **▲** or **▼** to highlight **Swap**. Press the **SELECT** softkey to resume the original call. The other incoming cell call is put on hold.

Using the telephone base:

- Press the **SWAP** softkey on the telephone base. The original call is put on hold and you can take the new call.
- Press the **OPTION** softkey on the telephone base. Press **▲DIR**, **▼CID**, **▲/DELETE** or **▼/REC** to highlight **Swap**. Press the **SELECT** softkey to resume the original call. The other incoming cell call is put on hold.

Make, answer and end a call

Answer an incoming cell call while on line 1 or line 2

If you are on a call using line 1 or line 2 and you receive an incoming cell call, **A** (📞) or (📞) **B** displays on the cordless handset and telephone base. You hear a beep on the device you are using and other devices ring.

To answer the incoming cell call:

Using a cordless handset:

- Press (📞) **CELL** on the handset. The call on line 1 or line 2 is automatically placed on hold. The other cordless handsets and telephone base display either **L1) ON HOLD** or **L2) ON HOLD**, and **CL) IN USE**.

Using the telephone base:

- Press **CELLULAR** (📞) on the telephone base. The call on line 1 or line 2 is automatically placed on hold. The cordless handsets display either **L1) ON HOLD** or **L2) ON HOLD**, and **CL) IN USE**.

To end the cell call:

Using a cordless handset:

- Press (🔌) **OFF/CLEAR** on the handset. The call on the corresponding line is still on hold. The cordless handset and telephone base display either **L1) ON HOLD** or **L2) ON HOLD**.

Using the telephone base:

- Press **CELLULAR** (📞) on the telephone base. The call on the corresponding line is still on hold. The cordless handset displays either **L1) ON HOLD** or **L2) ON HOLD**.

To resume the call on hold on line 1 or line 2:

Using a cordless handset:

- Press **1 LINE/FLASH** or **2 LINE/FLASH** on the handset to take the corresponding call off of hold.

Using the telephone base:

- Press **1 LINE** or **2 LINE** on the telephone base to take the corresponding call off of hold.

i **NOTE:** If you have voicemail service active on your cell phone, and you do not answer the incoming cell call, the call is answered by your cell phone's voicemail. Contact your cell phone service provider for more information about voicemail service.

Make, answer and end a call

Answer an incoming call on line 1 or line 2 while on a cell call

If you are on a cell call and you receive an incoming call on line 1 or line 2, you hear a beep on the device you are using while the other devices ring. **Line 1 Incoming call** or **Line 2 Incoming call** displays on the handset and telephone base.

To answer the incoming call on line 1 or line 2:

Using a cordless handset:

- Press **1 LINE/FLASH** or **2 LINE/FLASH** on the handset for the ringing line. The cell call is automatically placed on hold. The other cordless handsets and telephone base display **CL) ON HOLD** and either **L1) IN USE** or **L2) IN USE**.

Using the telephone base:

- Press **1 LINE** or **2 LINE** on the telephone base for the ringing line. The cell call is automatically placed on hold. The cordless handset displays **CL) ON HOLD** and either **L1) IN USE** or **L2) IN USE**.

To end a call on line 1 or line 2:

Using a cordless handset:

- Press  **OFF/CLEAR** on the handset. The cell line is still on hold. The other handset(s) and telephone base display **CL) ON HOLD**.

Using the telephone base:

- Press **1 LINE** or **2 LINE** on the telephone base for the corresponding line or return the corded handset to the telephone base if you are using it. The cell line is still on hold. The telephone base and handset display **CL) ON HOLD**.

To resume the cell call on hold:

Using a cordless handset:

- Press  **CELL** on the handset.

Using the telephone base:

- Press **CELLULAR**  on the telephone base.

 **NOTE:** If you have turned on your answering system and you do not answer the incoming call on line 1 or line 2, the call is answered by your answering system.

Conference calls

Conference calls on line 1 and line 2

While you are on a call on line 1, and line 2 is on hold or in use, you can conference line 1 and line 2 using a handset or the telephone base.

To conference both line 1 and line 2:

1. Press the **OPTION** softkey on the handset or telephone base.
2. Press the **SELECT** softkey to choose **Conference**.
3. The conferencing handsets or telephone base show **Lines now in conference**.

To select an option while on a conference call:

1. Press the **OPTION** softkey on the handset or telephone base.
2. Press **▲** or **▼** on the handset or **▲DIR**, **▼CID**, **▲/DELETE** or **▼/REC** on the telephone base to select one of the following options:
 - **End Line 1** - Hang up on line 1 and continue speaking on line 2.
 - **End Line 2** - Hang up on line 2 and continue speaking on line 1.
 - **End Conference**
 - **Directory**
 - **Call log**
3. Press the **SELECT** softkey to confirm.

To end a conference call:

- Press  **OFF/CLEAR** on the cordless handset or put it back in the charger.
-OR-
- Press **1 LINE** or **2 LINE** on the telephone base to drop the lines individually.
-OR-
- Press the **OPTION** softkey on the handset or telephone base. Then press **▲** or **▼** on the handset, or **▲DIR**, **▼CID**, **▲/DELETE** or **▼/REC** on the telephone base to select **End Conference**. Press the **SELECT** softkey to confirm.
-OR-
- Put the corded handset back to the telephone base to end the conference call.

Conference calls

Answer an incoming call on line 1 or line 2 during a conference call

If you subscribe to call waiting service from your telephone service provider, you hear a beep if someone calls while you are already on a conference call. If you subscribe to caller ID service from your telephone service provider, you see the incoming call information.

To answer the incoming call while on a conference call:

- On the handset, press **1 LINE/FLASH** or **2 LINE/FLASH** respectively.
-OR-
- On the telephone base, press **FLASH** once to access line 1 in waiting. Press **FLASH** a second time to access line 2 in waiting. Press **FLASH** a third time to return all original parties to the conference call.

NOTES:

- When you answer an incoming call during a conference call, the new party joins in the conference call and places the line's original party on hold.
- Contact your telephone service provider for more information about call waiting (page 68), caller ID (page 108) and voicemail service (page 117).

To return all original parties on a conference call:

- On the handset, press **1 LINE/FLASH** or **2 LINE/FLASH** respectively. The original party on the corresponding line joins back in the conference call.
-OR-
- On the telephone base, press **FLASH** to end the incoming call. Depending upon the line of incoming call, you may continue pressing **FLASH** until all of the original parties have returned to the conference call.

 NOTE: When you end the incoming call during a conference call, the new party exits from the conference call and the original party on the corresponding line joins back the conference call.

Conference calls

Conference call on line 1 or line 2 with a cell call

When you have calls established on line 1 or line 2, and the cell line, you can create a 3-way conference.

To conference line 1 or line 2 with a cell call:

1. Press the **OPTION** softkey on the handset or telephone base.
2. Press the **SELECT** softkey to choose **Conference**.
3. The conferencing handsets or telephone base show **Lines now in conference**.
4. All lines in use or on hold join a conference together.

To select an option while on a conference call:

1. Press the **OPTION** softkey on the telephone base or handset.
2. Press **▲** or **▼** on the handset, or **▲DIR**, **▼CID**, **▲/DELETE** or **▼/REC** on the telephone base to select one of the following options:
 - **End Line 1/End Line 2** (whichever is applicable)
 - **End Cell line**
 - **End Conference**
 - **Directory**
 - **Call log**
3. Press the **SELECT** softkey.

To end a conference call:

- Press **↶OFF/CLEAR** on the handset or put the handset back in the charger, or return the corded handset to the telephone base.
- OR-
- Press **1 LINE**, **2 LINE** or **SPEAKER** **⏏**) on the telephone base to drop the lines individually.

Using line 1, line 2 and cell line together:

- The handset and telephone base can access line 1, line 2 or the cell line independently when the lines are not in conference.
- You cannot be on a call using the cell line and a Bluetooth headset via line 1 or line 2 at the same time. These are both Bluetooth devices and only one can be used at a time.
- If you are on a call using the cell line, you cannot use the microphone and earpiece on your connected cell phone to join the call.

Options while on calls

Speakerphone

Using a cordless handset:

During a call, press **☎/SPEAKER** on the handset to switch between the speakerphone and cordless handset.

Dial-in-Base Speakerphone

Using the corded handset:

During a call, press **SPEAKER ☎** on the telephone base to switch between the speakerphone and corded handset.

Using the telephone base:

During a call, press **SPEAKER ☎** to end a call.

Volume control

While on a call, you can adjust the listening volume on the handset or telephone base.

If this is a cell call and the volume is too loud, too quiet or drops out, try changing the volume on your cell phone. On some cell phones, changing the volume on the cell phone effects your cell call volume on the **TL86109** corded and cordless handset(s).

To adjust the listening volume of a cordless handset:

- Press **▲/VOL** or **VOL/▼** on the handset while on a call.

To adjust the listening volume of the telephone base:

- Press **▼/VOLUME** or **VOLUME/▲** on the telephone base while on a call.

i NOTE: The handset earpiece volume setting (1-5) and speakerphone volume setting (1-6) are independent. The speakerphone volume setting of the telephone base (1-8) is also independent.

Silencing the ringer

When the telephone is ringing, you can temporarily silence the ringer of the handset or telephone base without disconnecting the call. The next call rings normally at the preset volume.

To silence the handset ringer:

- Press the **SILENCE** softkey. **Ringer muted** appears.
-OR-
- Press **VOL/▼** repeatedly until the handset displays **Ringer muted**. Press the **SET** softkey to confirm.
-OR-
- Press **▲/VOL** or **VOL/▼** and then press the **OFF** softkey. The handset displays **Ringer muted**.

Options while on calls

To silence the base ringer:

- Press the **SILENCE** softkey. **Ringer muted** appears.
-OR-
- Press **▼ VOLUME** repeatedly until the telephone base displays **Ringer muted**. Press the **SET** softkey to confirm.
-OR-
- Press **▼/VOLUME** or **VOLUME/▲** and then press the **OFF** softkey. The telephone base displays **Ringer muted**.

Mute

Use the mute function to turn off the microphone. You can hear the caller, but the caller cannot hear you.

To mute a call on a cordless handset or the telephone base:

- Press the **MUTE** softkey to turn off the microphone. When mute is on, the cordless handset or telephone base shows **Microphone off** for a few seconds and **MUTE** appears until you turn off the mute function.

To take a call off mute:

- Press the **UNMUTE** softkey and resume speaking. When mute is off, **Microphone ON** appears temporarily on the cordless handset or telephone base.

Mute is automatically canceled when you end the call.

Temporary tone dialing

If you have pulse (rotary) service only, you can switch from pulse to touch-tone dialing temporarily during a call. This is useful if you need to send touch-tone signals to access your telephone banking or long distance services.

During a call:

1. Press **TONE X** on the handset or telephone base.
2. Use the dialing keys to enter the relevant number. The telephone sends touch-tone signals.
3. The telephone automatically returns to pulse dialing mode after you end the call.

Options while on calls

Hold

You can place a call on hold. You hear an alert tone at the telephone base if you have not taken the call off of hold after 14 minutes. You hear another alert tone at the telephone base 30 seconds later. At 15 minutes on hold, the call on hold automatically disconnects.

To place a line 1 or line 2 call on hold:

- Press **HOLD** on the handset or telephone base. **L1) ON HOLD** or **L2) ON HOLD** appears on the handset and telephone base. The corresponding line buttons on the handset and telephone base flash.

To resume a line 1 or line 2 call on hold:

- Press the corresponding line button: **1 LINE/FLASH** or **2 LINE/FLASH** on the handset, or **1 LINE** or **2 LINE** on the telephone base.

To place a cell call on hold:

- Press **HOLD** on the handset or telephone base. **CL) ON HOLD** appears on the handset and telephone base. **CELL** on the handset and **CELLULAR** on the telephone base flash.

To resume a cell call on hold:

- Press **CELL** on the handset or **CELLULAR** on the telephone base.

i **NOTE:** When two or more handsets, or one or more handsets and the base are on a call, if you press **HOLD**, you will be disconnected from the call. The call continues on the other system phones.



Equalizer

The equalizer feature on the handset enables you to change the quality of the handset audio to best suit your hearing.

While on a call, or listening to a message or announcement, press **EQ** to select the equalizer setting **Treble 1**, **Treble 2**, **Bass** or **Natural** (the default setting) for the handset. The current setting is shown on the handset for two seconds.

i **NOTES:**

- The equalizer feature does not apply to the telephone base or the connected Bluetooth headset.
- If you switch the call between the handset and speakerphone by pressing **Speaker**, the audio setting remains unchanged.
- The current equalizer setting remains unchanged until a new setting is selected.



Options while on calls

Chain dialing

Use this feature to initiate a dialing sequence from numbers stored in the directory, call log or redial while you are on a call.

Chain dialing can be useful if you wish to access other numbers (such as bank account numbers or access codes) from the directory, call log or redial list.

To access a number in the directory while on a call:

Using a cordless handset:

1. Press the **OPTION** softkey.
2. Press **▲** or **▼** to highlight **Directory**, then press the **SELECT** softkey.
3. If there are more than one directory, press **▲** or **▼** to highlight the desired directory, then press the **SELECT** softkey.
4. Press **▲** or **▼** to scroll to the desired entry or perform an alphabetical search (page 99).
5. Press the **DIAL** softkey to dial the displayed number.

Using the telephone base:

1. Press the **OPTION** softkey.
2. Press **▲DIR**, **▼CID**, **▲/DELETE** or **▼/REC** to highlight **Directory**, then press the **SELECT** softkey.
3. If there are more than one directory, press **▲DIR**, **▼CID**, **▲/DELETE** or **▼/REC** to highlight the desired directory, then press the **SELECT** softkey.
4. Press **▲DIR**, **▼CID**, **▲/DELETE** or **▼/REC** to scroll to the desired entry or perform an alphabetical search (page 99).
5. Press the **DIAL** softkey to dial the displayed number.

Options while on calls

To access a number in the call log while on a call:

Using a cordless handset:

1. Press the **OPTION** softkey.
2. Press **▲** or **▼** to highlight **Call log**, then press the **SELECT** softkey.
3. If you have more than one call log, press **▲** or **▼** to highlight the desired call log, then press the **SELECT** softkey.
4. Press **▲** or **▼** to scroll to the desired entry.
5. Press the **DIAL** softkey to dial the displayed number.

Using the telephone base:

1. Press the **OPTION** softkey.
2. Press **▲DIR**, **▼CID**, **▲/DELETE** or **▼/REC** to highlight **Call log**, then press the **SELECT** softkey.
3. If you have more than one call log, press **▲DIR**, **▼CID**, **▲/DELETE** or **▼/REC** to highlight the desired call log, then press the **SELECT** softkey.
4. Press **▲DIR**, **▼CID**, **▲/DELETE** or **▼/REC** to scroll to the desired entry.
5. Press the **DIAL** softkey to dial the displayed number.

To access the redial list while on a call:

Using a cordless handset:

1. Press **REDIAL/PAUSE**.
2. Press **▲** or **▼** until the desired number displays, then press the **DIAL** softkey.

Using the telephone base:

1. Press **REDIAL**.
2. Press **▲DIR**, **▼CID**, **▲/DELETE** or **▼/REC** until the desired number displays, then press the **DIAL** softkey.

NOTES:

- You can only view the numbers in the directory, call log or redial list while on a call and cannot edit, delete or save entries.
- Press the **BACK** softkey on the handset, or press **CANCEL** on the telephone base to exit the redial, directory or call log while on a call.

Redial

Each handset and the telephone base stores the last 20 dialed numbers (up to 30 digits each) on the redial list. The redial entries of each handset and the telephone base are independent.

Review the redial list

To review the redial list of a cordless handset:

1. Press **REDIAL/PAUSE** in idle mode.
2. Press **▲** or **▼** to browse. The handset beeps twice at the end of the list.

Press **OFF/CLEAR** to exit.

To review the redial list of the telephone base:

1. Press **REDIAL** in idle mode.
2. Press **▲DIR**, **▼CID**, **▲/DELETE** or **▼/REC** to browse. The telephone base beeps twice at the end of the list.

Press **CANCEL** to exit.



Dial a redial entry

To dial a redial entry of a cordless handset:

1. Press **1 LINE/FLASH** or **2 LINE/FLASH** to use the corresponding line or **CELL** to use the cell line. Then press **REDIAL/PAUSE** to enter the redial list.
2. Press **▲** or **▼** to browse until the desired number displays. The handset beeps twice at the end of the list.
3. Press the **DIAL** softkey to dial the number displayed.

You can also select a redial entry before dialing.

1. Press **REDIAL/PAUSE** in idle mode.
2. Press **▲** or **▼** to browse until the desired number displays. The handset beeps twice at the end of the list.
3. Press **1 LINE/FLASH** or **2 LINE/FLASH** to use the corresponding line or **CELL** to use the cell line.

i **NOTE:** You may also press **)/SPEAKER** to dial a redial entry. The default line for the speakerphone is determined by the line preference setting. To change the setting, see page 33.

Redial

To dial a redial entry of the telephone base:

1. Lift the corded handset, or press **1 LINE** or **2 LINE**. Then press **REDIAL** to enter the redial list.
2. Press **▲DIR**, **▼CID**, **▲/DELETE** or **▼/REC** to browse and then press the **DIAL** softkey to dial the number displayed.



You can also select a redial entry before dialing.

1. Press **REDIAL** in idle mode.
2. Press **▲DIR**, **▼CID**, **▲/DELETE** or **▼/REC** to browse until the desired number displays. The telephone base beeps twice at the end of the list.
3. Press **1 LINE** or **2 LINE** to use the corresponding line, or press **CELLULAR** to use the cell line.

i NOTE: You may also lift the corded handset or press **SPEAKER** to dial a redial entry. The default line for the corded handset and speakerphone are determined by the line preference setting. To change the setting, please see page 43.

Save a redial entry to the directory

Using a cordless handset:

1. Press **REDIAL/PAUSE** in idle mode.
2. Press **▲** or **▼** to browse until the desired number displays.
3. Press the **SAVE** softkey.
4. The handset displays **ENTER NUMBER**. Use the dialing keys to edit the number, if necessary.
 - Press **OFF/CLEAR** to erase a digit.
 - Press **▲** to move the cursor to the right or **▼** to the left.
 - Press and hold **REDIAL/PAUSE** to insert a dialing pause (a **p** appears).
5. Press the **NEXT** softkey.
6. The handset displays **SELECT TYPES**. Press **▲** or **▼** to select one of the following types:
 - Home
 - Cell
 - Work
 - Other
7. Press the **NEXT** softkey. The handset displays **ENTER NAME**. Use the dialing keys (page 95) to enter a name.
 - Press **OFF/CLEAR** to erase a character.
 - Press **▲** to move the cursor to the right or **▼** to the left.
8. Press the **SAVE** softkey to confirm and you hear a confirmation tone.

Redial

Using the telephone base:

1. Press **REDIAL** in idle mode.
2. Press **▲DIR**, **▼CID**, **▲/DELETE** or **▼/REC** to browse until the desired number displays.
3. Press the **SAVE** softkey.
4. The telephone base displays **ENTER NUMBER**. Use the dialing keys to edit the number, if necessary.
 - Press **CANCEL** to erase a digit.
 - Press **▲DIR** or **▶/SKIP** to move the cursor to the right. Press **▼CID** or **◀/REPEAT** to move to the left.
 - Press the **PAUSE** softkey to insert a dialing pause (a **p** appears).
5. Press the **NEXT** softkey.
6. The handset displays **SELECT TYPES**. Press **▲DIR**, **▼CID**, **▲/DELETE** or **▼/REC** to select one of the following types:
 - Home
 - Cell
 - Work
 - Other
7. Press the **NEXT** softkey. The telephone base displays **ENTER NAME**. Use the dialing keys (page 95) to enter a name.
 - Press **CANCEL** to erase a character.
 - Press **▲DIR** or **▶/SKIP** to move the cursor to the right. Press **▼CID** or **◀/REPEAT** to move to the left.
8. Press the **SAVE** softkey to confirm and you hear a confirmation tone.

Delete a redial entry

Using a cordless handset:

1. Press **REDIAL/PAUSE** when the handset is not in use.
2. Press **▲** or **▼** to browse until the desired number displays.
3. Press the **DELETE** softkey to delete the displayed number.

Using the telephone base:

1. Press **REDIAL** when the telephone base is not in use.
2. Press **▲DIR**, **▼CID**, **▲/DELETE** or **▼/REC** to browse until the desired number displays.
3. Press the **DELETE** softkey to delete the displayed number.

Telephone operation

Handset locator

This feature helps you find a misplaced handset.

To start paging:

1. Press the **MENU** softkey on the telephone base in idle mode.
2. Press **▲/DIR**, **▼/CID**, **▲/DELETE** or **▼/REC** to highlight **Page all handsets**, then press the **SELECT** softkey. The telephone base displays **Paging all handsets** and your handset screen displays ****Paging****.



To end paging:

Press the **STOP** softkey on the telephone base.

-OR-

Press **DIR/▲**, **▼/CID**, **1 LINE/FLASH**, **2 LINE/FLASH**, **☎CELL**, **📞OFF/CLEAR**, **🔊/SPEAKER**, **HOLD**, **REDIAL/PAUSE** or any dialing key (**0-9**, **#** or **TONE ✕**) on the handset.

NOTES:

- If the handset ringer volume is set to off, the handset still rings when being paged.
- While the telephone base is paging, you may press the **SILENCE** softkey on the handset to mute the paging tone.
- If there is no response after 60 seconds, paging ends.

Share an outside call

Join a call in progress

Another handset can join you on an outside call. That call continues until all people hang up. You can share an outside call with up to four system handsets.

Using a cordless handset:

- Press the corresponding line button (**1 LINE/FLASH** or **2 LINE/FLASH**) or **CELL** on another handset to join the call.
- Press **OFF/CLEAR** or place the handset in the charger to hang up. The call continues until all handsets and the telephone base hang up.

Using the telephone base:

- Lift the corded handset; press **1 LINE** or **2 LINE** to join the call on the respective line, or press **CELLULAR** for the cell line.
- Place the corded handset in the telephone base or press the corresponding line button (**1 LINE**, **2 LINE** or **CELLULAR**) to hang up. The call continues until all handsets and the telephone base hang up.

NOTES:

- You can use a maximum of four cordless system handsets and the telephone base at the same time on an outside call.
- The default line for the corded handset is determined by the line preference setting. To change the setting, please see page 43.

Intercom

Use the intercom feature for conversations between the telephone base and the cordless handset, or two cordless handsets.

You can buy additional expansion handsets (**TL86009**) for this telephone system. You can register up to 12 handsets to the telephone base.

To initiate an intercom call:

Using a cordless handset:

1. Press the **MENU** softkey on the handset in idle mode.
2. Press **▲** or **▼** to highlight **INTERCOM**, then press the **SELECT** softkey.

- If you have only one cordless handset, press the **SELECT** softkey and the handset displays **Calling base**. The telephone base rings and displays **Handset is calling**.

- If you have two or more handsets, your handset displays **INTERCOM TO:**

- Press the **SELECT** softkey to choose **BASE**.

-OR-

Press **0** for **BASE** and then press the **SELECT** softkey.

Your handset displays **Calling base**. The telephone base rings and displays **Handset X is calling** while **1 LINE** and **2 LINE** flash.

-OR-

- Press **▲** or **▼** to choose a destination handset, and then press the **SELECT** softkey.

-OR-

Press **1-9** for **HANDSET 1-9**, ***0** for **HANDSET 10**, ***1** for **HANDSET 11** or ***2** for **HANDSET 12**, and then press the **SELECT** softkey to initiate an intercom call.

Your handset displays **Calling handset X** and the destination handset rings and displays **Handset X is calling** while **1 LINE/FLASH** and **2 LINE/FLASH** flash.

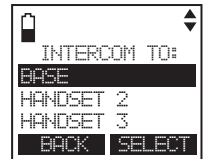
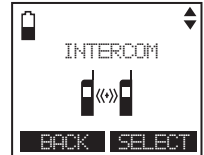

To answer an intercom at the destination handset:

- Press **1 LINE/FLASH**, **2 LINE/FLASH** or **Ⓜ/SPEAKER**. Both screens show **Intercom**.

To answer an intercom at the telephone base:

- Press **1 LINE**, **2 LINE** or **SPEAKER** (Ⓜ), or lift the corded handset to answer the intercom call. Both screens show **Intercom**.

To silence an intercom call:

- Press the **SILENCE** softkey on the destination handset or telephone base. Its screen displays **Ringer muted** for a few seconds.

Intercom

To mute while on an intercom call:

- Press the **MUTE** softkey on the handset or telephone base. Its screen displays **Microphone off** for a few seconds.

To end an intercom call at the destination handset:

- Press **OFF/CLEAR** or the **END** softkey, or place either cordless handset back in the charger. Both screens display **Intercom ended**.

To end an intercom call at the telephone base:

- Press the **END** softkey or return the corded handset to the telephone base. Both screens display **Intercom ended**.

NOTES:

- You can cancel the intercom call before it is answered by pressing **OFF/CLEAR** on your originating handset.
- If the destination handset or telephone base does not answer the intercom call within 100 seconds, is in the directory or call log, or is out of range, the originating handset displays **Unable to call. Try again.** and returns to idle mode.
- You can use a maximum of five handsets at a time. For example, when four handsets are used on intercom calls, use another handset for an outside call. When two handsets are used on an intercom call, you can use three other handsets for an outside call.

Using the telephone base:

1. Press the **MENU** softkey on the telephone base in idle mode.
2. Press **▲DIR**, **▼CID**, **▲/DELETE** or **▼/REC** to highlight **Intercom**, then press the **SELECT** softkey.



- If you have only one cordless handset, the telephone base displays **Calling handset**. The handset rings and displays **Base is calling** while **1 LINE/FLASH** and **2 LINE/FLASH** flash.
 - If you have two or more cordless handsets, the telephone base displays **INTERCOM TO:**
 - Press **▲DIR**, **▼CID**, **▲/DELETE** or **▼/REC** to choose a destination handset then press the **SELECT** softkey.
- OR-**



Press **1-9** for **HANDSET 1-9**, ***0** for **HANDSET 10**, ***1** for **HANDSET 11** or ***2** for **HANDSET 12**, and then press the **SELECT** softkey to initiate an intercom call.

The telephone base displays **Calling handset X**. The destination handset rings and displays **Base is calling** while **1 LINE/FLASH** and **2 LINE/FLASH** flash.

Intercom

To answer an intercom at the destination handset:

- Press **1 LINE/FLASH**, **2 LINE/FLASH** or **☎/SPEAKER**. Both screens show **Intercom**.

To silence an intercom call:

- Press the **SILENCE** softkey on the destination handset. Its screen displays **Ringer muted** for a few seconds.

To mute while on an intercom call:

- Press the **MUTE** softkey on the handset or telephone base. Its screen displays **Microphone off** for a few seconds.

To end an intercom call at the destination handset:

- Press **☎ OFF/CLEAR** or the **END** softkey, or place the cordless handset back in the charger. Both screens display **Intercom ended**.

To end an intercom call at the telephone base:

- Press the **END** softkey or return the corded handset to the telephone base. Both screens display **Intercom ended**.

NOTES:

- You can cancel the intercom call before it is answered by pressing **CANCEL** on the telephone base.
- If the destination handset does not answer the intercom call within 100 seconds, is in the directory or call log, or is out of range, the telephone base displays **Unable to call. Try again.** and returns to idle mode.
- You can use a maximum of five handsets at a time. For example, when four handsets are used on intercom calls, use another handset for an outside call. When two handsets are used on an intercom call, you can use three other handsets for an outside call.

Intercom

To answer a line 1 or line 2 call during an intercom call:

When you receive an incoming call on line 1 or line 2 during an intercom call, there is an alert tone. **Line 1 Incoming call** or **Line 2 Incoming call** displays and **1 LINE/FLASH** or **2 LINE/FLASH** flashes. The telephone rings.



Using a cordless handset:

- Press **1 LINE/FLASH** or **2 LINE/FLASH** to answer the corresponding call and the intercom call ends automatically.
- Press  **OFF/CLEAR**, or press the **BACK** softkey and then the **END** softkey to end the intercom call without answering the incoming call. The telephone continues to ring.



Using the telephone base:

- Press **1 LINE** or **2 LINE** to answer the corresponding call and the intercom call ends automatically.
- Press the **BACK** softkey and then the **END** softkey to end the intercom call without answering the incoming call. The telephone continues to ring.



To answer a cell call during an intercom call:

When you receive an incoming cell call during an intercom call, there is an alert tone. The cellular phone name and the incoming number displays.  **CELL** on the cordless handset and **CELLULAR**  on the telephone base flash. The telephone rings.

Using a cordless handset:

- Press  **CELL** to answer the cell call and the intercom call ends automatically.
- Press  **OFF/CLEAR** to end the intercom call without answering the incoming call. The telephone continues to ring.

Using the telephone base:

- Press **CELLULAR**  to answer the cell call and the intercom call ends automatically.
- Press **SPEAKER** , or return the corded handset to the telephone base if it is in use to end the intercom call without answering the incoming call. The telephone continues to ring.

Call transfer using intercom

Use the intercom feature to transfer an outside call to another system handset or the telephone base.

To transfer an outside call:

Using a cordless handset:

1. When on an outside call, press the **OPTION** softkey.
2. Press **▲** or **▼** to highlight **Intercom**, then press the **SELECT** softkey.
 - If you have only one cordless handset, press the **SELECT** softkey and the handset displays **Calling base**. The telephone base rings and displays **Handset is calling**.
 - If you have two or more cordless handsets, your handset displays **INTERCOM TO:**

- Press the **SELECT** softkey to select **BASE**.

-OR-

Press **0** for **BASE** and then press the **SELECT** softkey.

Your handset displays **Calling base**. The telephone base rings and displays **Handset X is calling**.

-OR-

- Press **▲** or **▼** to choose a destination handset, then press the **SELECT** softkey.

-OR-

Press **1-9** for **HANDSET 1-9**, ***0** for **HANDSET 10**, ***1** for

HANDSET 11 or ***2** for **HANDSET 12**, and then press the **SELECT** softkey to initiate an intercom call.

Your handset displays **Calling handset X** and the destination handset rings and displays **Handset X is calling**.

3. To answer the call on the other handset, press **1 LINE/FLASH**, **2 LINE/FLASH** or **Ⓜ/SPEAKER**. The outside call is still on hold and both handsets now show **Intercom**. You can now have a private conversation between the system handsets.

-OR-

To answer the call on the telephone base, press **1 LINE**, **2 LINE** or **SPEAKER Ⓜ**. The outside call is still on hold and both the handset and telephone base now show **Intercom**. You can now have a private conversation between the telephone base and the handset.

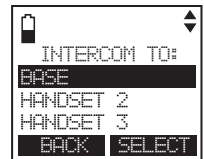

Call transfer using intercom

iNOTES:

- To cancel the transfer and return to the external call before the intercom call is answered, press **OFF/CLEAR** on your handset.
- If the destination handset or the telephone base is in use, accessing the directory or call log, out of range, or does not answer the intercom call within 100 seconds, the calling handset shows **Unable to call. Try again.** and automatically returns to the external call.

4. From this intercom call, you have the following options:

- You can transfer the call. Press the **OPTION** softkey and then the **SELECT** softkey to select **Transfer** on the calling handset, or put the original handset in the charger. The original handset displays **Call transferred**. The other handset or telephone base automatically connects to the outside call.
- You can let the other handset or the telephone base join you on the outside call in a three-way conversation. Press the **OPTION** softkey. Press **▲** or **▼** to highlight **Share call** and then press the **SELECT** softkey.
- You can end the intercom call and continue the outside call on the original handset. Press the **END** softkey on the destination handset or put it in the charger, or press **OFF/CLEAR** on the original handset. The destination handset displays **Intercom ended**.

Using the telephone base:

1. When on an outside call, press the **OPTION** softkey.
2. Press **▲DIR**, **▼CID**, **▲/DELETE** or **▼/REC** to highlight **Intercom**, then press the **SELECT** softkey.

- If you have only one cordless handset, the outside call is put on hold and the telephone base displays **Calling handset**. The cordless handset rings and displays **Base is calling**.
- If you have two or more cordless handsets, the telephone base displays **INTERCOM TO:**
 - Press **▲DIR**, **▼CID**, **▲/DELETE** or **▼/REC** to choose a destination handset then press the **SELECT** softkey.



-OR-

Press **1-9** for **HANDSET 1-9**, ***0** for **HANDSET 10**, ***1** for **HANDSET 11** or ***2** for **HANDSET 12**, and then press the **SELECT** softkey to initiate an intercom call.

The telephone base displays **Calling handset X**. The destination handset rings and displays **Base is calling**.

Call transfer using intercom

3. To answer the call on the other handset, press **1 LINE/FLASH**, **2 LINE/FLASH** or **◀)/SPEAKER**. The outside call is still on hold and both the handset and the telephone base now show **Intercom**. You can now have a private conversation between the cordless handset and the telephone base.

NOTES:

- To cancel the transfer and return to the external call before the intercom call is answered, press **CANCEL** on the telephone base.
 - If the destination handset is in use, accessing the directory or call log, out of range, or does not answer the intercom call within 100 seconds, the telephone base shows **Unable to call. Try again.** and automatically returns to the external call.
4. From this intercom call, you have the following options:
 - You can transfer the call. Press the **OPTION** softkey and then the **SELECT** softkey to select **Transfer** on the telephone base. The telephone base displays **Call transferred**. The destination handset automatically connects to the outside call.
 - You can let the other handset join you on the outside call in a three-way conversation. Press the **OPTION** softkey. Press **▲DIR**, **▼CID**, **▲/DELETE** or **▼/REC** to highlight **Share call** and then press the **SELECT** softkey.
 - You can end the intercom call and continue the outside call on the telephone base. Press **☞ OFF/CLEAR** or the **END** softkey on the destination handset; or put it in the charger. The destination handset displays **Intercom ended**.
 - You can end the intercom call and continue the outside call on the destination handset. Press **1 LINE**, **2 LINE** or **SPEAKER ◀)** on the telephone base, or return the corded handset in the telephone base. The telephone base displays **Call transferred**.

About the directory

The home directory stores up to 200 entries with up to 30 digits for each phone number and 15 characters for each name. You can store up to four downloaded directories. Each of the downloaded directories stores up to 1,500 entries with up to 30 digits for each phone number and 15 characters for each name.

- Directory entries are stored at the telephone base and shared by all system handsets. Any changes made on one handset or the telephone base apply to all.
- Only one handset or the telephone base can review the directory at a time. If another handset tries to enter the directory, its screen shows **Not available at this time.**
- When you try to enter the directory with no records, the screen shows **Directory empty.**
- When the directory is full and you try to save an entry, the screen shows **Directory is full.**
- When you try to save a number already stored in the directory, the screen shows **Already saved.**

All of the instructions on pages 93-107 for the directories apply to the home directory and all downloaded directories. Creating a new entry on pages 93-97 only applies to the home directory.

You cannot create new entries in your downloaded directories from the **TL86109**. Entries must be downloaded from your cell phone (see **Download directory** on pages 28-29).

Create and review entries

Create a new entry in the home directory

Using a cordless handset:

1. Press the **MENU** softkey on the handset in idle mode to enter the main menu.
2. Press **▲** or **▼** to highlight **DIRECTORY**, then press the **SELECT** softkey.
3. Press the **SELECT** softkey again to select **Home**.
4. Press **▲** or **▼** to highlight **Add contact**, then press the **SELECT** softkey. The screen displays **ENTER NUMBER**.
5. Use the dialing keys to enter a telephone number.
 - Press **↶** **OFF/CLEAR** to erase a digit.
 - Press **▲** to move the cursor to the right or **▼** to the left.
 - Press and hold **REDIAL/PAUSE** to insert a dialing pause (a **p** appears).

-OR-

Copy a number from the redial list.

- i. Press **REDIAL/PAUSE** and then **▲** or **▼** to browse to select a number.
 - ii. Press the **INSERT** softkey to copy the displayed number.
6. Press the **NEXT** softkey.
 7. The screen displays **SELECT TYPE**. Press **▲** or **▼** to select one of the following types:
 - Home
 - Cell
 - Work
 - Other
 8. Press the **NEXT** softkey. The screen displays **ENTER NAME**.
 9. Use the dialing keys (see page 95) to enter a name.
 - Press **↶** **OFF/CLEAR** to erase a character.
 - Press **▲** to move the cursor to the right or **▼** to the left.
 10. Press the **SAVE** softkey to confirm and the screen shows **Saved**.

i **NOTE:** You cannot create new entries in your downloaded directories from your **TL86109**. Entries must be downloaded from your cell phone (see **Download directory** on pages 28-29).

Create and review entries

Using the telephone base:

1. Press the **MENU** softkey on the telephone base in idle mode to enter the main menu.
2. Press **▲DIR**, **▼CID**, **▲/DELETE** or **▼/REC** to highlight **Directory**, then press the **SELECT** softkey.
3. Press the **SELECT** softkey again to select **Home**.
4. Press **▲DIR**, **▼CID**, **▲/DELETE** or **▼/REC** to highlight **Add contact**, then press the **SELECT** softkey. The screen displays **ENTER NUMBER**.
5. Use the dialing keys to enter a telephone number.
 - Press **CANCEL** to erase a digit.
 - Press **▲DIR** or **▶/SKIP** to move the cursor to the right. Press **▼CID** or **◀/REPEAT** to move to the left.
 - Press the **PAUSE** softkey to insert a dialing pause (a **p** appears).

-OR-

Copy a number from the redial list.

- i. Press **REDIAL** and then **▲DIR**, **▼CID**, **▲/DELETE** or **▼/REC** to browse to select a number.
 - ii. Press the **INSERT** softkey to copy the displayed number.
6. Press the **NEXT** softkey.
7. The screen displays **SELECT TYPE**. Press **▲DIR**, **▼CID**, **▲/DELETE** or **▼/REC** to select one of the following types:
 - Home
 - Cell
 - Work
 - Other
8. Press the **NEXT** softkey. The screen displays **ENTER NAME**.
9. Use the dialing keys (see page 95) to enter a name.
 - Press **CANCEL** to erase a character.
 - Press **▲DIR** or **▶/SKIP** to move the cursor to the right. Press **▼CID** or **◀/REPEAT** to move to the left.
10. Press the **SAVE** softkey to confirm and the screen shows **Saved**.

 **NOTE:** You cannot create new entries in your downloaded directories from your **TL86109**. Entries must be downloaded from your cell phone (see **Download directory** on pages 28-29).

Create and review entries

Number key	Characters by number of key presses										
	1	2	3	4	5	6	7	8	9	10	11
1	1	.	-	'	()	*	#	&	/	,
2	A	B	C	a	b	c	2				
3	D	E	F	d	e	f	3				
4	G	H	I	g	h	i	4				
5	J	K	L	j	k	l	5				
6	M	N	O	m	n	o	6				
7	P	Q	R	S	p	q	r	s	7		
8	T	U	V	t	u	v	8				
9	W	X	Y	Z	w	x	y	z	9		
0	Space	0									
*											
#											

 **NOTE:** When entering a name in the directory, the first letter of each word is automatically capitalized.

Add a predialed telephone number to the directory

You can save a predialed telephone number to the directory.

To add a predialed telephone number:

Using a cordless handset:

1. Enter the telephone number in idle mode (see step 5 in **Create a new entry in the home directory** on page 93).
2. Press the **SAVE** softkey and then the handset displays **ENTER NUMBER**.
3. Use the dialing keys to edit the number.
 - Press **OFF/CLEAR** to erase a digit.
 - Press **▲** to move the cursor to the right or **▼** to the left.
 - Press and hold **REDIAL/PAUSE** to insert a dialing pause (a **p** appears).
4. Press the **NEXT** softkey.
5. The screen displays **SELECT TYPE**. Press **▲** or **▼** to select one of the following types:
 - Home
 - Cell
 - Work
 - Other
6. Press the **NEXT** softkey. The screen displays **ENTER NAME**.
7. Use the dialing keys (see page 95) to enter a name.
 - Press **OFF/CLEAR** to erase a character.
 - Press **▲** to move the cursor to the right or **▼** to the left.
8. Press the **SAVE** softkey to confirm and the screen shows **Saved**. You hear a confirmation tone.

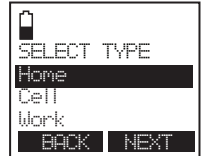

Create and review entries

Using the telephone base:

1. Enter the telephone number in idle mode (see step 5 in **Create a new entry in the home directory** on page 94).
2. Press the **SAVE** softkey and then the telephone base displays **ENTER NUMBER**.
3. Use the dialing keys to edit the number.
 - Press **CANCEL** to erase a digit.
 - Press **▲DIR** or **▶/SKIP** to move the cursor to the right. Press **▼CID** or **◀/REPEAT** to move to the left.
 - Press the **PAUSE** softkey to insert a dialing pause (a **p** appears).
4. Press the **NEXT** softkey.
5. The screen displays **SELECT TYPE**. Press **▲DIR**, **▼CID**, **▲/DELETE** or **▼/REC** to select one of the following types:
 - Home
 - Cell
 - Work
 - Other
6. Press the **NEXT** softkey. The screen displays **ENTER NAME**.
7. Use the dialing keys (see page 95) to enter a name.
 - Press **CANCEL** to erase a character.
 - Press **▲DIR** or **▶/SKIP** to move the cursor to the right. Press **▼CID** or **◀/REPEAT** to move to the left.
8. Press the **SAVE** softkey to confirm and the screen shows **Saved**. You hear a confirmation tone.

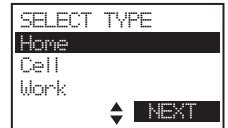
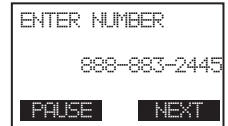

Review the directory

Entries are sorted alphabetically.

To review the directory:

Using a cordless handset:

1. Press **DIR/▲** in idle mode.
2. Press **▲** or **▼** to choose a directory, then press the **SELECT** softkey.
3. Press **▲** or **▼** to browse.

-OR-

1. Press the **MENU** softkey on the handset in idle mode to enter the main menu.
2. Press **▲** or **▼** to highlight **DIRECTORY**, then press the **SELECT** softkey.
3. Press **▲** or **▼** to choose a directory, then press the **SELECT** softkey.
4. Press the **SELECT** softkey again to choose **Review**.
5. Press **▲** or **▼** to browse.

Using the telephone base:

1. Press **▲DIR** in idle mode.
2. Press **▲DIR**, **▼CID**, **▲/DELETE** or **▼/REC** to choose a directory, then press the **SELECT** softkey.
3. Press **▲DIR**, **▼CID**, **▲/DELETE** or **▼/REC** to browse.

-OR-

1. Press the **MENU** softkey on the telephone base in idle mode to enter the main menu.
2. Press **▲DIR**, **▼CID**, **▲/DELETE** or **▼/REC** to highlight **Directory**, then press the **SELECT** softkey.
3. Press **▲DIR**, **▼CID**, **▲/DELETE** or **▼/REC** to choose a directory, then press the **SELECT** softkey.
4. Press the **SELECT** softkey again to choose **Review**.
5. Press **▲DIR**, **▼CID**, **▲/DELETE** or **▼/REC** to browse.

 **NOTE:** When the desired entry displays, press **#** (pound key) on the handset or telephone base repeatedly to show different dialing options.

3-character alphabetical search

You can use the enhanced 3-character search to find your contacts quickly and efficiently.

To start the search:

1. Follow the steps in **Review the directory** on the previous page to enter the directory.
2. When an entry appears, use the dialing keys to enter the letters associated with the name (see page 95). You can enter up to three letters for the search. The letters will show at the top left hand corner of the screen. After you have entered one to three letters, the system starts searching in the directory. If there is no name matching the letter(s) entered, the next closest match in alphabetical order appears. If necessary, press ▲ or ▼ on the handset, or ▲/DIR, ▼/CID, ▲/DELETE or ▼/REC on the telephone base to browse.

 **NOTE:** The cursor automatically moves to the next position two seconds after you enter a letter. If you do not enter another letter in the coming two seconds, the system starts searching in the directory.

Dial, edit or delete a directory

Dial a directory entry

You can dial a directory entry on any line.

To dial a directory entry:

1. Search for the desired entry in the directory (see **Review the directory** and **3-character alphabetical search** on pages 98-99).
2. When the desired entry appears, press **#** (pound key) repeatedly on the handset or telephone base to show different dialing options.
3. When the displayed number is in the correct format, press **1 LINE/FLASH**, **2 LINE/FLASH** or **⏏)/SPEAKER** on the handset, or press **1 LINE, 2 LINE** or **SPEAKER ⏏)** on the telephone base, or lift the corded handset on the telephone base to use line 1 or line 2. Press **☎)CELL** on the handset or **CELLULAR ☎)** on the telephone base to use the cell line.

Dial, edit or delete a directory

Edit a directory entry

You may edit any directory entry. However, be aware that if you download from a cell phone again, the directory is erased and replaced with the current cell phone directory. If you have edited the downloaded entry on the **TL86109**, those changes are lost. To avoid losing changes made to the downloaded directory, we suggest you edit the number in your cell phone, then download the directory.

Using a cordless handset:

1. Search for the desired entry in the directory (see **Review the directory** and **3-character alphabetical search** on pages 98-99).
2. When the desired entry appears, press the **EDIT** softkey. The screen shows **EDIT NUMBER**.
3. Use the dialing keys to edit the number.
 - Press **OFF/CLEAR** to erase a digit.
 - Press **▲** to move the cursor to the right or **▼** to the left.
 - Press and hold **REDIAL/PAUSE** to insert a dialing pause (a **p** appears).
4. Press the **NEXT** softkey.
5. The screen displays **SELECT TYPE**. Press **▲** or **▼** to select one of the following types:
 - Home
 - Cell
 - Work
 - Other
6. Press the **NEXT** softkey. The screen displays **EDIT NAME**.
7. Use the dialing keys (see page 95) to edit the name.
 - Press **OFF/CLEAR** to erase a character.
 - Press **▲** to move the cursor to the right or **▼** to the left.
8. Press the **SAVE** softkey to confirm and the screen shows **Saved**.

Dial, edit or delete a directory

Using the telephone base:

1. Search for the desired entry in the directory (see **Review the directory** and **3-character alphabetical search** on pages 98-99).
2. When the desired entry appears, press the **EDIT** softkey. The screen shows **EDIT NUMBER**.
3. Use the dialing keys to edit the number.
 - Press **CANCEL** to erase a digit.
 - Press **▲DIR** or **▶/SKIP** to move the cursor to the right. Press **▼CID** or **◀/REPEAT** to move to the left.
 - Press the **PAUSE** softkey to insert a dialing pause (a **p** appears).
4. Press the **NEXT** softkey.
5. The screen displays **SELECT TYPE**. Press **▲DIR**, **▼CID**, **▲/DELETE** or **▼/REC** to select one of the following types:
 - Home
 - Cell
 - Work
 - Other
6. Press the **NEXT** softkey. The screen displays **EDIT NAME**.
7. Use the dialing keys (see page 95) to edit the name.
 - Press **CANCEL** to erase a character.
 - Press **▲DIR** or **▶/SKIP** to move the cursor to the right. Press **▼CID** or **◀/REPEAT** to move to the left.
8. Press the **SAVE** softkey to confirm and the screen shows **Saved**.

Dial, edit or delete a directory

Edit the type of a directory entry

If you only want to edit the type of a directory entry:

1. Search for the desired entry in the directory (see **Review the directory** and **3-character alphabetical search** on pages 98-99).
2. When the desired entry appears, enter the corresponding shortcut keys in the below table on the handset or telephone base. The type you choose will appear on the screen between the name and number.

Type:	Press:
Home	✕ 1
Cell	✕ 2
Work	✕ 3
Other	✕ 4

Delete a directory entry

To delete an entry:

1. Search for the desired entry in the directory (see **Review the directory** and **3-character alphabetical search** on pages 98-99).
2. When the desired entry appears, press the **DELETE** softkey on the handset or telephone base. The screen displays **Delete contact?**
3. Press the **YES** softkey on the handset or telephone base. The screen displays **Deleted** and then the next alphabetical entry in the directory.



NOTE: Once a directory entry is deleted, it cannot be retrieved.

Remove a downloaded directory

Using a cordless handset:

1. Press the **MENU** softkey in idle mode to enter the main menu.
2. Press **▲** or **▼** to highlight **DIRECTORY** and then press the **SELECT** softkey.
3. Press **▲** or **▼** to choose the desired downloaded directory, then press the **SELECT** softkey.
4. Press **▲** or **▼** to highlight **Remove dir** and then press the **SELECT** softkey.
5. The screen displays **Directory XXXX will be erased**. Press the **YES** softkey and the screen displays **Directory removed**. You hear a confirmation tone.

Using the telephone base:

1. Press the **MENU** softkey in idle mode to enter the main menu.
2. Press **▲DIR**, **▼CID**, **▲/DELETE** or **▼/REC** to highlight **Directory** and then press the **SELECT** softkey.
3. Press **▲DIR**, **▼CID**, **▲/DELETE** or **▼/REC** to choose the desired downloaded directory, then press the **SELECT** softkey.
4. Press **▲DIR**, **▼CID**, **▲/DELETE** or **▼/REC** to highlight **Remove dir** and then press the **SELECT** softkey.
5. The screen displays **Directory XXXX will be erased**. Press the **YES** softkey and the screen displays **Directory removed**. You hear a confirmation tone.

Store a speed dial directory entry

You can store up to 10 entries in the speed dial memory locations. All speed dial entries are shared by all system handsets and the telephone base.

Using a cordless handset:

1. Press the **MENU** softkey when the handset is not in use.
2. Press **▲** or **▼** to select **DIRECTORY** and then press the **SELECT** softkey.
3. Press **▲** or **▼** to select **Speed dial**, then press the **SELECT** softkey. The screen shows a list from **1:** to **0:**
4. Press **▲** or **▼** to select a desired speed dial number, then press the **ASSIGN** softkey.
5. Press **▲** or **▼** to browse and select an entry from the directory, then press the **ASSIGN** softkey to confirm your selection.

-OR-

If there is more than one directory, the screen shows the directories listed in alphabetical order. Press **▲** or **▼** to select the desired directory, then press the **SELECT** softkey. Press **▲** or **▼** to browse and select an entry from the directory, then press the **ASSIGN** softkey to confirm your selection. You may also press the **DIR** softkey to select the desired directory again.

Using the telephone base:

1. Press the **MENU** softkey when the telephone base is not in use.
2. Press **▲DIR**, **▼CID**, **▲/DELETE** or **▼/REC** to select **Directory** and then press the **SELECT** softkey.
3. Press **▲DIR**, **▼CID**, **▲/DELETE** or **▼/REC** to select **Speed dial**, then press the **SELECT** softkey. The screen shows a list from **1:** to **0:**
4. Press **▲DIR**, **▼CID**, **▲/DELETE** or **▼/REC** to select a desired speed dial number, then press the **ASSIGN** softkey.
5. Press **▲DIR**, **▼CID**, **▲/DELETE** or **▼/REC** to browse and select an entry from the directory, then press the **ASSIGN** softkey to confirm your selection.

-OR-

If there is more than one directory, the screen shows the directories listed in alphabetical order. Press **▲DIR**, **▼CID**, **▲/DELETE** or **▼/REC** to select the desired directory, then press the **SELECT** softkey. Press **▲DIR**, **▼CID**, **▲/DELETE** or **▼/REC** to browse and select an entry from the directory, then press the **ASSIGN** softkey to confirm your selection. You may also press the **DIR** softkey to select the desired directory again.

Review the speed dial directory

Using a cordless handset:

1. Press the **MENU** softkey when the handset is not in use.
2. Press **▲** or **▼** to select **DIRECTORY** and then press the **SELECT** softkey.
3. Press **▲** or **▼** to select **Speed dial**, then press the **SELECT** softkey.
4. Press **▲** or **▼** to browse.

Using the telephone base:

1. Press the **MENU** softkey when the telephone base is not in use.
2. Press **▲DIR**, **▼CID**, **▲/DELETE** or **▼/REC** to select **Directory** and then press the **SELECT** softkey.
3. Press **▲DIR**, **▼CID**, **▲/DELETE** or **▼/REC** to select **Speed dial**, then press the **SELECT** softkey.
4. Press **▲DIR**, **▼CID**, **▲/DELETE** or **▼/REC** to browse.

Dial a speed dial entry

Using a cordless handset:

1. Press and hold an assigned number to display the desired speed dial entry.
2. Press **1 LINE/FLASH**, **2 LINE/FLASH** or **☎/SPEAKER** to make a line 1 or line 2 call. Press **☎CELL** to make a cell call.

Using the telephone base:

1. Press and hold an assigned number to display the desired speed dial entry.
2. Press **1 LINE**, **2 LINE** or **SPEAKER ☎**) or lift the corded handset to make a line 1 or line 2 call. Press **CELLULAR ☎**) to make a cell call.

Reassign a speed dial entry

Using a cordless handset:

1. Press the **MENU** softkey to enter the main menu in idle mode.
2. Press **▲** or **▼** to highlight **DIRECTORY** and then press the **SELECT** softkey.
3. Press **▲** or **▼** to highlight **Speed dial** and then press the **SELECT** softkey.
4. Press **▲** or **▼** to highlight a desired speed dial slot and then press the **ASSIGN** softkey.
5. Press **▲** or **▼** to scroll to a desired directory entry and then press the **ASSIGN** softkey. The handset displays **Directory A replaces Directory B Accept?**
6. Press the **YES** softkey to confirm and you hear a confirmation tone.

Speed dial directory

Using the telephone base:

1. Press the **MENU** softkey to enter the main menu in idle mode.
2. Press **▲DIR**, **▼CID**, **▲/DELETE** or **▼/REC** to highlight **Directory** and then press the **SELECT** softkey.
3. Press **▲DIR**, **▼CID**, **▲/DELETE** or **▼/REC** to highlight **Speed dial** and then press the **SELECT** softkey.
4. Press **▲DIR**, **▼CID**, **▲/DELETE** or **▼/REC** to highlight a desired speed dial slot and then press the **ASSIGN** softkey.
5. Press **▲DIR**, **▼CID**, **▲/DELETE** or **▼/REC** to scroll to a desired directory entry and then press the **ASSIGN** softkey. The telephone base displays **Directory A replaces Directory B Accept?**
6. Press the **YES** softkey to confirm and you hear a confirmation tone.

Delete a speed dial entry

Using a cordless handset:

1. Press the **MENU** softkey to enter the main menu in idle mode.
2. Press **▲** or **▼** to highlight **DIRECTORY** and then press the **SELECT** softkey.
3. Press **▲** or **▼** to highlight **Speed dial** and then press the **SELECT** softkey.
4. Press **▲** or **▼** to highlight a desired speed dial slot and then press the **DELETE** softkey.
5. The handset displays **Delete Directory A speed dial assignment?**
6. Press the **YES** softkey to confirm and you hear a confirmation tone.

Using the telephone base:

1. Press the **MENU** softkey to enter the main menu in idle mode.
2. Press **▲DIR**, **▼CID**, **▲/DELETE** or **▼/REC** to highlight **Directory** and then press the **SELECT** softkey.
3. Press **▲DIR**, **▼CID**, **▲/DELETE** or **▼/REC** to highlight **Speed dial** and then press the **SELECT** softkey.
4. Press **▲DIR**, **▼CID**, **▲/DELETE** or **▼/REC** to highlight a desired speed dial slot and then press the **DELETE** softkey.
5. The telephone base displays **Delete Directory A speed dial assignment?**
6. Press the **YES** softkey to confirm and you hear a confirmation tone.

 **NOTE:** Deleting a speed dial entry does not affect the directory entry.

About caller ID

This product supports caller ID services provided by most telephone service providers. Caller ID allows you to see the name, number, date and time of calls. The available caller ID information appears after the first or second ring.

Information about caller ID with call waiting

Caller ID with call waiting lets you see the name and telephone number of the caller before answering the telephone, even while on another call.

It may be necessary to change your telephone service to use this feature. Contact your telephone service provider if:

- You have both caller ID and call waiting, but as separate services (you may need to combine these services).
- You have only caller ID service, or only call waiting service.
- You do not subscribe to caller ID or call waiting services.



There are fees for caller ID services. In addition, services may not be available in all areas.

Caller ID information is available only if both you and the caller are in areas offering caller ID service, and if both telephone service providers use compatible equipment.

The caller ID information may not be available for every incoming call. The callers may intentionally block their names and/or telephone numbers. A call log entry can show a maximum number of 24 digits.

i NOTE: You can use this product with regular caller ID service, or you can use this product's other features without subscribing to caller ID or combined caller ID with call waiting service.

Caller ID operation

How the caller ID history (call log) works

The telephone stores caller ID information about the last 50 incoming calls in each call log (line 1, line 2, Cell A and Cell B) in the telephone base. Entries are stored in reverse chronological order. The system deletes the oldest entry when the log is full to make room for new calls. This information is common to all handset(s) and the telephone base, so changes made using any handset are reflected in all other handsets. If you answer a call before the information appears on the screen, it does not show in the caller ID history.

i NOTE: If the phone number has more than 24 digits, it will not be saved or shown in the call log.

Missed call indicator

The handset and telephone base display **XX Missed** when they are in idle mode and have missed or new calls.

All new missed calls that have not been reviewed are counted as missed calls. Each time you review a call log entry with the icon **NEW**, the number of missed calls decreases by one.

To clear the missed call indicator, see **Display alerts** on pages 33 and 43.

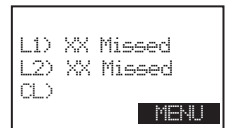

Caller ID operation

Memory match

If the incoming telephone number matches the last seven digits of a telephone number in your directory, the name that appears on the screen matches the corresponding name in your directory.

For example, if Christine Smith calls, her name appears as **Chris** if this is how you entered it into your directory.

i **NOTE:** The number you see on your caller ID is in the format from the telephone service provider. It usually delivers 10-digit telephone numbers (area code plus telephone number). If the last seven digits of the incoming telephone number do not match a number in your directory, the name appears as it is delivered by the telephone service provider.

Review the call log

Review the caller ID history to find out who called, to easily return a call, or to copy the caller's name and number into your directory. **Call log empty** appears if there are no records in the call log.

Using a cordless handset:

1. Press **▼/CID** on the handset while in idle mode.

-OR-

Press the **MENU** softkey to enter the main menu, then press **▲** or **▼** to scroll to **CALL LOG** and then press the **SELECT** softkey.

2. If you have only one call log, press the **SELECT** softkey again to choose **Review**.

-OR-

If you have more than one call log, press **▲** or **▼** to highlight the desired call log, then press the **SELECT** softkey twice to choose **Review**.

3. Press **▲** or **▼** to scroll through the list. Press and hold **OFF/CLEAR** to exit the caller ID history.



▼/CID

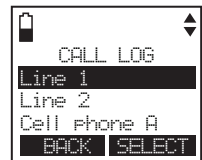

Handset screen display



Caller ID operation

Using the telephone base:

1. Press **▼CID** on the telephone base while in idle mode.

-OR-

Press the **MENU** softkey to enter the main menu and then press **▲DIR**, **▼CID**, **▲/DELETE** or **▼/REC** to scroll to **Call log**. Press the **SELECT** softkey.

2. If you have only one call log, press the **SELECT** softkey again to choose **Review**.

-OR-

If you have more than one call log, press **▲DIR**, **▼CID**, **▲/DELETE** or **▼/REC** to choose a desired call log and then press the **SELECT** softkey twice to choose **Review**.

3. Press **▲DIR**, **▼CID**, **▲/DELETE** or **▼/REC** to scroll through the list. Press and hold **CANCEL** to exit the caller ID history.

Telephone base screen display



i **NOTE:** Only one handset or the telephone base can review the caller ID history at a time. If another handset or the telephone base tries to enter the call log, it shows **Not available at this time**.

Caller ID operation

View dialing options

Although the call log entries may contain 10 digits (the area code plus the seven-digit number), in some areas, you may need to dial only the seven digits, or 1 plus the seven digits, or 1 plus the area code plus the seven digits. You can change the number of digits that you dial from the call log or store to the directory.

While reviewing the call log, press **#** (pound key) repeatedly to show different dialing options for local and long distance numbers before dialing or saving the telephone number in the directory.

```

888-883-2445
1-888-883-2445
883-2445
1-883-2445
    
```

Press **#**

Press **1** repeatedly if you need to add or remove 1 in front of the telephone number before dialing or saving it in the directory.

```

883-2445
1-883-2445
    
```

Press **1**

```

888-883-2445
1-888-883-2445
    
```

When the number shows the correct format for dialing:

- Press **1 LINE/FLASH**, **2 LINE/FLASH** or **Ⓜ)/SPEAKER** on the handset, or **1 LINE**, **2 LINE** or **SPEAKER Ⓜ)** on the telephone base, or lift the corded handset to call the number using line 1 or line 2.

-OR-

- Press **☎)CELL** on the handset or **CELLULAR ☎)** on the telephone base to call the number using the cell line.

Dial a call log entry

Using a cordless handset:

1. Search for the desired entry in the call log (see **Review the call log** on page 110).
2. When the desired entry is displayed and is in the correct format for dialing, press **1 LINE/FLASH** or **2 LINE/FLASH** on the handset to use the corresponding line. Press **☎)CELL** to use the cell line.

Use the telephone base:

1. Search for the desired entry in the call log (see **Review the call log** on page 111).
2. When the desired entry is displayed and is in the correct format for dialing, press **1 LINE** or **2 LINE** to use the corresponding line. Press **CELLULAR ☎)** to use the cell line.

Save a call log entry to the directory

Call log entries can only be saved to the **Home** directory.

To save a call log entry:

Using a cordless handset:

1. Select a desired entry in the call log (see **Review the call log** on page 110).
2. When the desired entry appears, press **#** repeatedly to show different dialing options.
3. When the number is in the correct format, press the **SAVE** softkey. The screen shows **EDIT NUMBER**.
4. Use the dialing keys to edit the number.
 - Press **OFF/CLEAR** to erase a digit.
 - Press **▲** to move the cursor to the right or **▼** to the left.
 - Press and hold **REDIAL/PAUSE** to insert a dialing pause (a **p** appears).
5. Press the **NEXT** softkey.
6. The screen displays **SELECT TYPE**. Press **▲** or **▼** to select one of the following types:
 - Home
 - Cell
 - Work
 - Other
7. Press the **NEXT** softkey. The screen displays **EDIT NAME**.
8. Use the dialing keys (see page 95) to edit the name.
 - Press **OFF/CLEAR** to erase a character.
 - Press **▲** to move the cursor to the right or **▼** to the left.
9. Press the **SAVE** softkey and you hear a confirmation tone.

Caller ID operation

Using the telephone base:

1. Select a desired entry in the call log (see **Review the call log** on page 111).
2. When the desired entry appears, press **#** (pound key) repeatedly to show different dialing options.
3. When the number is in the correct format, press the **SAVE** softkey. The screen shows **EDIT NUMBER**.
4. Use the dialing keys to edit the number.
 - Press **CANCEL** to erase a digit.
 - Press **▲DIR** or **▶/SKIP** to move the cursor to the right. Press **▼CID** or **◀/REPEAT** to move to the left.
 - Press the **PAUSE** softkey to insert a dialing pause (a **p** appears).
5. Press the **NEXT** softkey.
6. The screen displays **SELECT TYPE**. Press **▲DIR**, **▼CID**, **▲/DELETE** or **▼/REC** to select one of the following types:
 - Home
 - Cell
 - Work
 - Other
7. Press the **NEXT** softkey. The screen displays **EDIT NAME**.
8. Use the dialing keys (see page 95) to edit the name.
 - Press **CANCEL** to erase a character.
 - Press **▲DIR** or **▶/SKIP** to move the cursor to the right. Press **▼CID** or **◀/REPEAT** to move to the left.
9. Press the **SAVE** softkey and you hear a confirmation tone.

Caller ID operation

Delete from the call log

To delete a single entry:

1. Select a desired entry in the call log (see **Review the call log** on pages 110-111).
2. When the desired entry displays, press the **DELETE** softkey on the handset or telephone base. The screen shows the previous call log entry.

To delete all entries:

Using a cordless handset:

1. Press **▼/CID** to enter the call log.

-OR-

Press the **MENU** softkey on the handset in idle mode to enter the main menu. Press **▲** or **▼** to highlight **CALL LOG**, then press the **SELECT** softkey.

2. If you have more than one call log, press **▲** or **▼** to highlight a desired call log, then press the **SELECT** softkey.
3. Press **▲** or **▼** to highlight **Del all calls**, then press the **SELECT** softkey.
4. The screen displays **Delete all calls?** Press the **YES** softkey to clear all entries and you hear a confirmation tone.



Using the telephone base:

1. Press **CID▼** to enter the call log.

-OR-

Press the **MENU** softkey on the telephone base in idle mode to enter the main menu. Press **▲DIR**, **▼CID**, **▲/DELETE** or **▼/REC** to highlight **Call log**, then press the **SELECT** softkey.

2. If you have more than one call log, press **▲DIR**, **▼CID**, **▲/DELETE** or **▼/REC** to highlight a desired call log, then press the **SELECT** softkey.
3. Press **▲DIR**, **▼CID**, **▲/DELETE** or **▼/REC** to highlight **Del all calls**, then press the **SELECT** softkey.
4. The screen displays **Delete all calls?** Press the **YES** softkey to clear all entries and you hear a confirmation tone.



Caller ID operation

Reasons for missing caller ID information

There are occasions when other information or no information shows for various reasons:

On-screen message	Reason
L	It is a long distance call.
Private name	The caller prefers not to show the name.
Private number	The caller prefers not to show the phone number.
Private caller	The caller prefers not to show the phone number and name.
Unknown name	Your telephone service provider cannot determine the caller's name.
Unknown number	Your telephone service provider cannot determine the caller's number.
Unknown caller	No information is available about this caller.

About the answering system

Answering system and voicemail

Your telephone has separate indicators for two different types of voice messages: those recorded on its built-in answering system and those recorded in your service provider's voicemail (fees may apply). Your telephone's built-in answering system messages and voicemail messages are separate. Each alerts you to new messages differently.

If **Voicemail** and  display on the cordless handset and telephone base, your telephone service provider is indicating that it has new voicemail for you on the respective line. To listen to your voicemail, you typically dial an access number provided by your telephone service provider, followed by a security code or PIN.

Some service providers bundle or combine multiple services like voicemail and call waiting, so you may not be aware that you have voicemail. To check what services you have and how to access them, contact your telephone service provider.

To use your voicemail service rather than your answering system, turn off your answering system. To use your answering system rather than your voicemail service, contact your telephone service provider to deactivate your voicemail service. You can also use your telephone answering system and voicemail together by setting your built-in answering system to answer before voicemail answers as described below. To learn how to program your voicemail settings, contact your telephone service provider. Then, if you are on a call, or if the answering system is busy recording a message and you receive another call, the second caller can leave a voicemail message.

Set your answering system to answer calls at least two rings earlier than your voicemail is set to answer. For example, if your voicemail answers after six rings, set your answering system to answer after four rings. Some voicemail providers may program the delay before answering calls in seconds instead of rings. In this case, allow six seconds per ring when determining the appropriate setting.

About the answering system

Answering system new message indication

When there are new messages on the answering system, **XX New msgs** and **00** with the corresponding line indicator display on the handset and telephone base. The corresponding mailbox light on the telephone base flashes.

If the message alert tone is turned on, the telephone base beeps every 10 seconds when there are new messages.



Message capacity

The answering system of line 1 and line 2 can each record and store up to 99 messages. Each incoming message can be up to three minutes in length. The total storage capacity for the announcement, messages and memos is approximately 14 minutes. The actual recording time depends on individual message characteristics. Messages remain available for replay until you delete them.

If the answering system has less than three minutes of recording time, it announces, *"Less than three minutes to record."* The cordless handset and telephone base display **Ans sys low**.

If the memory is full, the answering system announces, *"Memory is full."* The cordless handset and telephone base display **Memory full**. You cannot record new messages until old ones have been deleted.

Voice prompts

The system provides voice prompts to guide you through remote access and recording announcements.

About the answering system

Call screening

If the answering system and call screening are on, the announcement and the incoming message broadcast at the telephone base when a call arrives. To change the call screening setting for all calls, see page 61.

To temporarily turn call screening on and off during message recording:

Using a cordless handset:

Press the **SCREEN** softkey or the **SILENCE** softkey to turn call screening on or off. Press **▲/VOL** or **VOL/▼** to adjust the message volume.

Using the telephone base:

Press the **SCREEN** softkey or the **SILENCE** softkey to turn call screening on or off. Press **▼ VOLUME** or **VOLUME ▲** to adjust the message volume.

 **NOTE:** During message recording, only one cordless handset can screen a call at a time.

Call intercept

If you want to talk to the caller who is recording a message on line 1 or line 2, press the corresponding line button or **◀) / SPEAKER** on the cordless handset; lift up the corded handset; or press the corresponding line button or **SPEAKER ◀)** on the telephone base.

Temporarily turning off the message alert tone

Pressing any telephone base key temporarily silences the message alert tone. The message alert tone plays with the next incoming message.

Message playback



If you have new messages, the telephone plays only the new messages (oldest first). If there are no new messages, the telephone plays all messages (oldest first). If you have no messages, the cordless handset or telephone base announces, *"You have no message."* and displays **You have: No message**.

When playback begins, you hear the total number of messages followed by the date and time of the message (see **Set date/time** on pages 37 and 47 for setting day and time). After the last message, the telephone announces, *"End of messages."* and the cordless handset or telephone base displays **End of messages**. If the recording time is less than three minutes, you hear, *"Less than three minutes to record."* (See **Message capacity** on page 118).

To listen to messages with a cordless handset:

1. Press the **MENU** softkey in idle mode.
2. Press the **SELECT** softkey to select **PLAY MESSAGES**.
3. Press **▲** or **▼** to select **Mailbox 1** or **Mailbox 2**, then press the **SELECT** softkey.
4. If there are new and old messages, the handset announces the number of new and old messages and the screen displays the number of new and old messages recorded. Press **▲** or **▼** to select **Play new msgs** or **Play old msgs**, then press the **SELECT** softkey. The screen displays the message status and **Ⓜ:Delete**.

Options during playback:

- Press **EQ**  to adjust the message playback audio quality.
- Press **▲/VOL** or **VOL/▼** to adjust the speakerphone volume.
- Press the **SKIP** softkey to skip to the next message.
- Press the **REPEAT** softkey to repeat the message currently playing. Press the **REPEAT** softkey twice to listen to the previous message.
- Press **3** to delete the current message. The system advances to the next message.
- Press  **OFF/CLEAR** to stop.

Message playback

To listen to messages at the telephone base:

Press **LINE 1** ►/■/MAILBOX or **LINE 2** ►/■/MAILBOX to listen to messages on the corresponding line. The handset announces the number of new and old messages and the screen displays the number of new and old messages recorded, then screen displays the message status and **ⓧ:Delete**.

-OR-

1. Press the **MENU** softkey in idle mode.
2. Press the **SELECT** softkey to select **PLAY MESSAGES**.
3. Press **▲** or **▼** to select **Mailbox 1** or **Mailbox 2**, then press the **SELECT** softkey.
4. If there are new and old messages, the telephone base announces the number of new and old messages and the screen displays the number of new and old messages recorded. Press **▲** or **▼** to select **Play new msgs** or **Play old msgs**, then press the **SELECT** softkey. The screen displays the message status and **ⓧ:Delete**.

Options during playback:

- Press **▼ VOLUME** or **VOLUME ▲** to adjust the speaker volume.
- Press **►/SKIP** or the **SKIP** softkey to skip to the next message.
- Press **◀/REPEAT** or the **REPEAT** softkey to repeat the message currently playing. Press **◀/REPEAT** or the **REPEAT** softkey twice to listen to the previous message.
- Press **▲/DELETE** or **3** to delete the current message. The system advances to the next message.
- Press **LINE 1** ►/■/MAILBOX, **LINE 2** ►/■/MAILBOX or **CANCEL** to stop listening to messages.

Delete all old messages

Using a cordless handset:

1. Press the **MENU** softkey on the handset in idle mode to enter the main menu.
2. Press **▲** or **▼** to scroll to **ANSWERING SYS** then press the **SELECT** softkey.
3. Press **▲** or **▼** to highlight **Mailbox 1** or **Mailbox 2**, then press the **SELECT** softkey.
4. Press **▲** or **▼** to highlight **Delete all old**, then press the **SELECT** softkey.
5. The handset displays **Delete all old messages?** Press the **YES** softkey to confirm. The handset displays **Deleting...** then **All old messages deleted** and you hear a confirmation tone.

Using the telephone base:

1. Press **▲/DELETE** on the telephone base when the phone is not in use.
2. Press **▲DIR**, **▼CID**, **▲/DELETE** or **▼/REC** to highlight **Mailbox 1** or **Mailbox 2**, then press the **SELECT** softkey.
3. The telephone base displays **Delete all old messages?** Press the **YES** softkey to confirm. The telephone base displays **Deleting...** then **All old messages deleted** and you hear a confirmation tone.

-OR-

1. Press the **MENU** softkey on the telephone base in idle mode to enter the main menu.
2. Press **▲DIR**, **▼CID**, **▲/DELETE** or **▼/REC** to highlight **Answering sys**, then press the **SELECT** softkey.
3. Press **▲DIR**, **▼CID**, **▲/DELETE** or **▼/REC** to highlight **Mailbox 1** or **Mailbox 2**, then press the **SELECT** softkey.
4. Press **▲DIR**, **▼CID**, **▲/DELETE** or **▼/REC** to highlight **Delete all old**, then press the **SELECT** softkey.
5. The telephone base displays **Delete all old messages?** Press the **YES** softkey to confirm. The telephone base displays **Deleting...** then **All old messages deleted** and you hear a confirmation tone.

NOTES:

- You can only delete old messages, which are messages you have played.
- If you have no old messages to delete, the screen displays **No message**.

Record, play and delete memos

Memos are messages you record as reminders for yourself or others using the same answering system. You can record your own memos using the cordless handset or telephone base. Play and delete them the same way as incoming messages.

To record a memo:

Using a cordless handset:

1. Press the **MENU** softkey on the handset in idle mode to enter the main menu.
2. Press ▲ or ▼ to scroll to **ANSWERING SYS**, then press the **SELECT** softkey.
3. Press ▲ or ▼ to highlight **Mailbox 1** or **Mailbox 2**, then press the **SELECT** softkey.
4. Press ▲ or ▼ to highlight **Record memo**, then press the **SELECT** softkey.
5. The system announces, *"Record after the tone. Press **STOP** when you are done."* After the tone, speak towards the microphone.
6. Press the **STOP** softkey when you finish recording. The handset announces, *"Recorded"* and then returns to the previous menu.

Message playback

Using the telephone base:

1. Press the **MENU** softkey on the telephone base in idle mode to enter the main menu.
2. Press **▲/DIR**, **▼/CID**, **▲/DELETE** or **▼/REC** to highlight **Answering sys**, then press the **SELECT** softkey.
3. Press **▲/DIR**, **▼/CID**, **▲/DELETE** or **▼/REC** to highlight **Mailbox 1** or **Mailbox 2**, then press the **SELECT** softkey.
4. Press **▲/DIR**, **▼/CID**, **▲/DELETE** or **▼/REC** to highlight **Record memo**, then press the **SELECT** softkey.
5. The system announces, *"Record after the tone. Press **STOP** when you are done."* After the tone, speak towards the microphone.
6. Press the **STOP** softkey when you finish recording. The telephone base announces, *"Recorded"* and then returns to the previous menu.

-OR-

1. Press **▼/REC** on the telephone base in idle mode to enter the main menu.
2. Press the **SELECT** softkey to choose **Memo**.
3. Press **▲/DIR**, **▼/CID**, **▲/DELETE** or **▼/REC** to highlight **Mailbox 1** or **Mailbox 2**, then press the **SELECT** softkey.
4. The system announces, *"Record after the tone. Press **STOP** when you are done."* After the tone, speak towards the microphone.
5. Press the **STOP** softkey when you finish recording. The telephone base announces, *"Recorded"* and then returns to idle mode.

NOTES:

- The system announces, *"Memory is full,"* if you attempt to record a memo when the memory is full.
- Each memo can be up to four minutes in length.
- Memos shorter than two seconds are not recorded.













Answering system
Remote access

You can access the answering system remotely by dialing your home telephone number from any touch-tone telephone.

To remotely access the answering system

1. Dial your telephone number from any touch-tone telephone.
2. When the system plays your announcement, enter the two-digit remote access code (**19** is the preset code; see page 63 to change it).
3. You can also enter the remote commands (see **Remote commands** below).
4. Hang up or press ***9** to end the call and save all undeleted messages.

Remote commands

















	Press to listen to all messages.
	Press to listen to new messages only.
	Press to delete the current message (during playback).
	Press twice to delete all old messages.
	Press to repeat the current message (during playback).
	Press to stop any operation (including recording).
	Press to listen to a list of remote commands.
	Press to skip to the next message (during playback).
	Press to record a new announcement in Annc A .
	Press to record a new announcement in Annc B .
	Press to end remote access (the call is terminated).
	Press to turn the answering system on or off.

 **NOTES:**

- If you do not press any keys after you enter the remote access code, all new messages play. If there are no new messages, all old messages play.
- Once the messages have played, the telephone announces the help menu options. If you do not press any key within 20 seconds, the remote access call automatically disconnects.
- When the answering system is turned off, the telephone answers after 10 rings, and announces, *"Please enter your remote access code."*
- When the memory is full, the answering system answers incoming calls after 10 rings and announces, *"Memory is full. Enter the remote access code."*

Appendix
Handset screen icons



	Battery status - the handset battery is charging (animated display). Becomes solid when the battery is fully charged.
	Battery status - flashes when the battery is low and needs charging.
	Line 1 - on steadily when line 1 is in use. Flashes when line 1 is on hold.
	Line 2 - on steadily when line 2 is in use. Flashes when line 2 is on hold.
	New voicemail - indicates you have new voicemail received on line 1 from the telephone service provider.
	New voicemail - indicates you have new voicemail received on line 2 from the telephone service provider.
	New voicemail - indicates you have new voicemail received on line 1 and line 2 from the telephone service provider.
	New answering system message - indicates you have new answering system message(s) on line 1.
	New answering system message - indicates you have new answering system message(s) on line 2.
	New answering system message - indicates you have new answering system message(s) on line 1 and line 2.
	Bluetooth connected device(s) - indicates that there are Bluetooth connected devices on the active devices list.
	Bluetooth disconnected device(s) - indicates that there are Bluetooth disconnected devices on the active devices list.
	Bluetooth link status - on steadily when the cell line or the Bluetooth headset is in use, or when you are downloading a cell phone directory.
	Speakerphone - the speakerphone is in use.
	Wired headset - on steadily when a wired headset is used during a call.
	New call log - indicates that the missed call is new and has not been reviewed.
	Mute - the microphone is muted.

Telephone base screen icons



	Line 1 - on steadily when line 1 is in use. Flashes when line 1 is on hold.
	Line 2 - on steadily when line 2 is in use. Flashes when line 1 is on hold.
	New voicemail - indicates you have new voicemail received on line 1 from the telephone service provider.
	New voicemail - indicates you have new voicemail received on line 2 from the telephone service provider.
	New voicemail - indicates you have new voicemail received on line 1 and line 2 from the telephone service provider.
	New answering system message - indicates you have new answering system message(s) on line 1.
	New answering system message - indicates you have new answering system message(s) on line 2.
	New answering system message - indicates you have new answering system message(s) on line 1 and line 2.
	Bluetooth connected device(s) - indicates that there are Bluetooth connected devices on the active device list.
	Bluetooth disconnected device(s) - indicates that there are Bluetooth disconnected devices on the active list.
	Bluetooth link status - on steadily when the cell line or the Bluetooth headset is in use, or when you are downloading a cell phone directory.
	Speakerphone - the speakerphone is in use.
	Bluetooth wireless headset - on steadily when a Bluetooth headset is used during a call.
	New call log - indicates that the missed call is new and has not been reviewed.
	Mute - the microphone is muted.

Appendix
Alert tones and lights

Handset alert tones

Two short beeps	You are pressing ▲ OR ▼ when the volume is already at its highest or lowest setting. -OR- You have reached the end of the caller ID history. -OR- You have reached the end of the redial list.
Three short beeps	The handset is out of range while on a call.
Three short rising beeps	The telephone has completed the command successfully.
Four short beeps	The cordless handset battery is low.
Four beeps (twice)	While you end an intercom call, the other cordless handset beeps.

Telephone base alert tones

Beeps once every 10 seconds You have new message(s) in the answering system.

Handset indicator lights



CELL

Flashes quickly when there is an incoming cell call.
Flashes slowly when a cell call is on hold.

CHARGE light

On when the handset is charging in the charger.

1 LINE/FLASH or 2 LINE/FLASH

Flashes quickly when there is an incoming line 1 or line 2 call.
Flashes slowly when a line 1 or line 2 call is on hold.

Backlight (lighted display and dial pad)

On when a key is pressed.

SPEAKER

On when the speakerphone is in use.

Telephone base indicator lights

⏻/ON/OFF LINE 1 and ⏻/ON/OFF LINE 2

On when the answering system of line 1 or line 2 is turned on.

DEVICE A and DEVICE B lights

On when the telephone base is paired and connected with a Bluetooth device.
Flash alternately while pairing a Bluetooth device.

Antenna light

On when the cell line is in use.

Flashes quickly when there is an incoming cell call.

SPEAKER light

On when the speakerphone is in use.

Cellular light

On when the cell line is in use.
Flashes quickly when there is an incoming cell call.
Flashes slowly when a cell call is on hold.

1 LINE and 2 LINE

On when line 1 or line 2 is in use.
Flashes quickly when there is an incoming call.
Flashes slowly when the call is on hold.

LINE 1 /MAILBOX and LINE 2 /MAILBOX

On when mailbox of line 1 or line 2 is playing the recorded messages.
Flashes when there are new messages in mailbox of line 1 or line 2.



Screen messages

Display screen messages

Already saved	The telephone number you have entered is already stored in the directory.
Ans sys full	The answering system has no recording time left.
Ans sys low	The answering system has less than three minutes to record.
Base is calling	The telephone base is calling another handset.
Bluetooth system busy	You are trying to make a cell call or access the Bluetooth menu when the Bluetooth link is already being used.
Call log empty	There are no entries in the caller ID history.
Calling base	A cordless handset is calling the telephone base.
Call transferred	An outside call from one handset is transferred to another handset or the telephone base.
Calling handset (for models with only one cordless handset)	The telephone base is calling the cordless handset (for intercom calls).
Calling handset X (for models with two or more cordless handsets)	The cordless handset or telephone base is calling another handset (for intercom calls).
Cell	The cell line is on a call.
Cellular phone not connected.	The cell phone is not connected with the telephone system.
Connection failed	A Bluetooth device failed to establish a connection with your telephone system.
Directory empty	There are no directory entries.
Directory is full	The directory is full. You cannot save any new entries unless you delete some current entries.
Ended	You have just ended a call.
Handset is calling (for models with only one cordless handset)	The handset is calling the telephone base (for intercom calls).
Handset X is calling (for models with two or more cordless handsets)	Another system handset is calling (for intercom calls).
IN USE	The home or cell line is in use.

Screen messages

Intercom	The cordless handset or telephone base is on an intercom call.
Intercom ended	The intercom call has just ended.
INTERCOM TO:	You have started the intercom process, and need to choose a cordless handset or the telephone base you wish to call.
Line 1 Incoming call	There is an incoming call on line 1.
Line 2 Incoming call	There is an incoming call on line 2.
Low battery	The battery needs to be charged.
Memory full	The answering system has no recording time left.
Microphone off	The cordless handset or telephone base microphone is off. The other party cannot hear you but you can hear the other party.
Microphone ON	The cordless handset or telephone base microphone is on.
No AC power. System can only access Line 1	There is no AC power. You can only use the corded handset and dialing keys to make and answer calls. Only line 1 is available in the event of a power failure.
No battery	The battery is not properly installed and the handset is in the charger.
No entries found. Try downloading from SIM memory only?	There are no entries found when you download a cell phone directory from the cell memory.
No entries found. Try downloading from phone memory only?	There are no entries found when you download a cell phone directory from your SIM card. There are no entries found in either the cell or SIM card when you download a cell phone directory from both memories.
No connected cellular phones	There is no cellular phone connected to the base.
NO LINE	There is no telephone line connected.
No message	There is no message recorded on the answering system.
No signal. Call ended.	The phone lost the connection with the telephone base or did not have a strong enough signal and the phone call ended.
Not available at this time	Someone else is already using the directory or caller ID history.
ON HOLD	A call has been put on hold.

Screen messages

Out of range OR no power at base	The handset has lost communication with the telephone base. There is no power connected to the telephone base.
** Paging **	The telephone base is paging all handsets.
Place in charger	The battery is very low. The handset should be placed in the charger.
Ringer muted	The ringer is muted temporarily during an incoming call.
Saved	The entry is now in the directory.
Unable to call. Try again.	Failed intercom or conference call.
Unable to complete call. Check cellular.	You are trying to make a cell call when the cell line is already being used.
Unable to save	You are trying to save an entry with no name and number from the caller ID history.
Voicemail	There are new voicemail message(s) from your telephone service provider.
** Missed	There are new calls in the caller ID history.
** New msg(s)	There are new messages recorded in the answering system.

Adding and using a DECT 6.0 cordless headset (optional)

You can add a maximum of two DECT 6.0 cordless headsets (purchased separately) to your telephone system. The first headset registered with the telephone base is assigned as **HEADSET 1** while the second headset is assigned as **HEADSET 2**.

You must register a DECT 6.0 cordless headset with the telephone base before use. If it is already registered with its base, you have to deregister it from its base before you can register it to your new **TL86109** telephone system. For more information, see the user's manual of your headset.

 **NOTE:** You cannot use the DECT 6.0 cordless headset that is already in use on an outside call to answer an incoming call on another line.

Add a DECT 6.0 cordless headset to your telephone system (optional)

To register a DECT 6.0 cordless headset:

1. Press and hold **HOLD** on the telephone base for about four seconds until it shows **Registering...Please wait**.
2. It takes up to 60 seconds to complete the registration. When the registration is completed, the telephone base displays **HEADSET Registered** and you hear a confirmation tone.

 **NOTE:** If the registration fails, the **ON/OFF** light on the DECT 6.0 cordless headset flashes twice every five seconds. Try the registration process again.

To deregister all DECT 6.0 cordless headsets:

1. Press and hold **FLASH** on the telephone base for about 4 seconds until it shows **Deregister all handsets?**
2. Press the **YES** softkey to continue. You hear a confirmation tone from the telephone base.
3. The telephone base displays **PLEASE WAIT...** The deregistration process takes about 10 seconds to complete. If the deregistration is successful, the **ON/OFF** light on the headset(s) flashes twice every five seconds.

NOTES:

- You cannot deregister the headset(s) if any other system handset or DECT 6.0 cordless headset is in use.
- During deregistration, all cordless handset(s) and DECT 6.0 cordless headset(s) will be deregistered.

Adding and using a DECT 6.0 cordless headset (optional)

To transfer an outside call to a DECT 6.0 cordless headset:**Using a cordless handset:**

1. When on an outside call, press the **OPTION** softkey.
2. If you have only one DECT 6.0 cordless headset, press the **SELECT** softkey to choose **Use HEADSET 1**. The outside call is put on hold and the handset displays **Transferring call to HEADSET 1**. The destination headset rings.

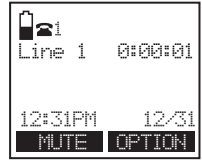

-OR-

If you have two DECT 6.0 cordless headsets, press **▲** or **▼** to choose **Use HEADSET 1** or **Use HEADSET 2** and then press the **SELECT** softkey. The outside call is put on hold and the handset displays **Transferring call to HEADSET X**. The destination headset rings.

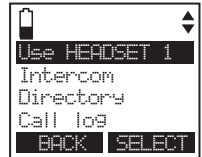

3. Press the **ON/OFF** key on your headset to answer the call. The handset displays **Call transferred**.

Using the telephone base:

1. When on an outside call, press the **OPTION** softkey.
2. If you have only one DECT 6.0 cordless headset, press the **SELECT** softkey to choose **Use HEADSET 1**. The outside call is put on hold and the telephone base displays **Transferring call to HEADSET 1**. The destination headset rings.



-OR-

If you have two DECT 6.0 cordless headsets, press **▲DIR**, **▼CID**, **▲/DELETE** or **▼/REC** to choose **Use HEADSET 1** or **Use HEADSET 2** and then press the **SELECT** softkey. The outside call is put on hold and the telephone base displays **Transferring call to HEADSET X**. The destination headset rings.



3. Press the **ON/OFF** key on your headset to answer the call. The telephone base displays **Call transferred**.

NOTES:

- See **Call transfer using intercom** on pages 89-91 for more details.
- Use only the AT&T DECT 6.0 cordless headset. To purchase, visit our website at **www.telephones.att.com** or call **1 (800) 222-3111**. In Canada, dial **1 (866) 288-4268**.

Expand your telephone system

The cordless handset provided with your telephone system is already registered. Additional handsets registered to the telephone system are assigned in sequential order. For instance, if you already have **HANDSET**, the new registered handset is assigned **HANDSET 2** and your first handset is then renamed as **HANDSET 1**. This telephone system accommodates up to 12 handsets.

Add and register a handset (optional)

You can add new handsets (**TL86009**, purchased separately) to your telephone system, but each handset must be registered with the telephone base before use. When first purchased, each expansion handset shows **Press [HOLD] on base for 4 sec, then press [#] on handset** after a battery is installed. Each handset should be charged without interruption for at least 25 minutes before registering to the telephone base. For more details on battery charging, see the table on page 12.

To register a handset:

1. **Press and hold HOLD** on the telephone base for about four seconds until it shows **Registering...Please wait**.
2. Press **#** (pound key) on the handset. Its screen shows **Registering handset...** and it takes up to 60 seconds to complete the registration. The handset and telephone base show **HANDSET X Registered** (X represents the handset number assigned) and you hear a beep when the registration is completed.



iNOTES:

- If the registration fails, the handset shows **Registration failed** for a few seconds and then **Press [HOLD] on base for 4 sec, then press [#] on handset**. Try the registration process again.
- You cannot register a handset if any other system handset is in use.
- You cannot register more than 12 handsets to the telephone base. **Registration slots are full** shows on the base screen while you are in step 2 above.

Replace a handset

If you want to replace a handset or reassign the designated handset number of a registered handset, you must deregister all the handsets and then individually register each handset.

To make deregistration easier, read all of the instructions on this page before you begin.

To deregister all handsets:

1. Press and hold **FLASH** on the telephone base for about 4 seconds until it shows **Deregister all handsets?**
2. Press the **YES** softkey to continue. You hear a confirmation tone from the telephone base.
3. The telephone base displays **PLEASE WAIT...** All system handsets show **Out of range OR no power at base** for a few seconds, and then you hear a confirmation tone from the handset.
4. All the handsets show **Press [HOLD] on base for 4 sec, then press [#] on handset** when the deregistration is completed. The deregistration process takes about 10 seconds to complete.

If deregistration fails, you may need to reset the telephone and try again.

To reset:

- Unplug the power from the telephone base, then plug it back in.

After deregistering, register each handset individually. See **Add and register a handset** on page 135.

NOTES:

- You cannot deregister the handset(s) if any other system handset is in use.
- During deregistration, all cordless handset(s) and DECT 6.0 cordless headset(s) will also be deregistered.

Troubleshooting

If you have difficulty with your telephone, please try the suggestions below. For customer service, or to purchase accessories or replacement parts, visit our website at **www.telephones.att.com**, or call **1 (800) 222-3111**. In Canada, dial **1 (866) 288-4268**. Have the serial number, found on the underside of your telephone, available when contacting for customer service.

I cannot pair my cell phone to the telephone base.

- Make sure you have cellular coverage.
- Make sure your cell phone is compatible with your **TL86109**. Check the Bluetooth compatibility list at **www.telephones.att.com**.
- Make sure the Bluetooth function of your cell phone is turned on. See the user's manual of your cell phone for more information.
- Make sure that you set your cell phone to search for devices.
- If the **TL86109** is in your cell phone device history list, delete it and try pairing again.
- Carefully follow the pairing instructions on pages 16-17 and make sure that your cell phone is not connected to any other Bluetooth device.
- Turn off your cell phone, then turn it on again.
- Reset the telephone base. Unplug the unit's electrical power. Wait for approximately 15 seconds, then plug it back in. Repeat the above suggestions.

I cannot pair my headset to the telephone base.

- Make sure that your Bluetooth headset is in discoverable mode when pairing with the telephone base. See the user's manual of your headset for more information on how to set your headset to discoverable mode.
- Make sure your headset is compatible with your **TL86109**. Check the Bluetooth compatibility list at **www.telephones.att.com**.
- Carefully follow the pairing instructions on pages 18-19 and make sure that your headset is not connected to any other Bluetooth device.
- Reset the telephone base. Unplug the unit's electrical power. Wait for approximately 15 seconds, then plug it back in. Repeat the above suggestions.

I cannot connect my cell phone with the telephone base.

- Make sure that the Bluetooth function of your cell phone is turned on. See the user's manual of your cell phone for more information.
- Make sure that your Bluetooth cell phone is not connected to any other Bluetooth device.
- Turn off your cell phone, then turn it on again.
- Make sure that your cell phone is on the active devices list.

Troubleshooting

- For some cell phones, you must authorize the **TL86109** device in your cell phone's Bluetooth feature. See the user's manual of your cell phone for more information.
- Manually connect your cell phone to the **TL86109**. Refer to the user's manual of your cell phone for more information.

I cannot connect my headset with the telephone base.

- Make sure that your Bluetooth headset is not connected to any other Bluetooth device.
- Make sure that your headset is on the active devices list.

I cannot put my headset in discoverable mode.

- Refer to the user's manual of your headset for information on how to set your headset to discoverable mode.
- Make sure that the headset is not connected to any other Bluetooth device in order to successfully pair and connect to the telephone base.
- Carefully follow the pairing process on pages 18-19.
- Reset the telephone base. Unplug the unit's electrical power. Wait for approximately 15 seconds, then plug it back in. Repeat the above suggestions.

I don't know how to search for or add new devices on my cell phone.

- Most cell phones have the Bluetooth feature in the connection or setup menus. Please refer to the user's manual of your cell phone.
- In general, press the menu key on your cell phone, then look for the Bluetooth menu in the settings or connection menu. In the Bluetooth menu, select the option to search for or add new devices.

My cell phone disconnects with the telephone base.

- Turn off your cell phone, then turn it on again.
- Make sure that you are not using your cell phone when on a cell call.

My cell phone is connected to the telephone base, but I cannot make a cell call.

- Make sure that your cell phone is not in use when you are trying to make a cell call.
- For some smartphones, make sure that the cellular function is turned on.

Bluetooth system busy appears on the display.

- Make sure that your cell phone is not in use when connected and on the active devices list.
- Make sure that your cell phone or headset is not connected to any other Bluetooth device.
- **TL86109** can only use one Bluetooth device at a time.

The PIN on the telephone base does not work.

- The default PIN is **0000**.
- If you have changed the PIN, it will appear on the telephone base in the pairing process.

I cannot hear any audio on my telephone system when on a cell call.

- Make sure that your cell phone's volume is not too low or muted.
- Reset the telephone base. Unplug the unit's electrical power. Wait for approximately 15 seconds, then plug it back in.
- Turn off your cell phone, then turn it on again.

The listening volume of my cell call is too loud or quiet.

- During a cell call, if the listening volume is too loud or quiet, try changing the volume on your cell phone. On some cell phones, changing the volume on the cell phone affects your cell call volume on the **TL86109**.

I cannot download contacts from my cell phone to my TL86109.

- Make sure that your cell phone is paired and connected to the base.
- Make sure you place your cell phone next to the base while downloading.

I see duplicate entries in my downloaded directory.

- If you see duplicate directory entries, you can delete them manually. Another option is to download again either your SIM card or phone memory, but not both.

Some of my cell phone contacts were not imported to my TL86109.

- Try copying the contacts from your SIM card to your cell phone memory first, then download from your phone memory. If that doesn't work, try copying the contacts from your cell phone memory to your SIM card, then download from your SIM card. For more information on how to transfer contacts between your SIM card and your phone memory, refer to the user's manual of your cell phone.

Can the TL86109 help the poor cell phone reception in my house?

- If your cell phone has poor reception in your home, the **TL86109** cannot improve the reception. However, if you have a location in your house with better reception, you can leave your cell phone in that location while you use the **TL86109** cell line. The cell phone must be within 15 feet of the telephone base for optimal performance.

Troubleshooting

My telephone doesn't work at all.

- Make sure the power cord is securely plugged in.
- Make sure that the battery connector is securely plugged into the cordless handset.
- Make sure the telephone line cord is securely and firmly plugged into the telephone cord line and the telephone wall jack.
- Charge the battery in the cordless handset for at least 16 hours. For optimum daily performance, return the cordless handset to the charger when not in use.
- If the battery is depleted, it may take approximately five minutes to charge the handset before you use it. See page 12 for details.
- Reset the telephone base. Unplug the electrical power. Wait for approximately 15 seconds, then plug it back in. Allow up to one minute for the cordless handset and telephone base to reset.
- You may need to purchase a new battery. Please refer to **Battery installation and charging** (pages 11-12) in this user's manual.

I cannot get a dial tone.

- Try all the suggestions above.
- Move the cordless handset closer to the telephone base. You might have moved out of range.
- If the previous suggestions do not work, disconnect the telephone base from the telephone jack and connect to a different phone. If there is no dial tone on that phone either, the problem is in your wiring or local service. Contact your telephone service provider.
- Your line cord may be defective. Try installing a new line cord.

I cannot dial out.

- Try all the suggestions in **I cannot get a dial tone** on page 140.
- Make sure you have a dial tone before dialing. The cordless handset may take a second or two to find the telephone base and produce a dial tone. This is normal. Wait an extra second before dialing.
- Eliminate any background noise. Noise from a television, radio or other appliances may cause the phone to not dial out properly. If you cannot eliminate the background noise, first try muting the cordless handset or the telephone base before dialing, or dialing from another room in your home with less background noise.
- If other phones in your home are having the same problem, the problem is in your wiring or local service. Contact your telephone service provider (charges may apply).

My cordless handset isn't performing normally.

- Make sure the power cord is securely plugged into the telephone base. Plug the power adapter into a different working electrical outlet not controlled by a wall switch.
- Move the cordless handset closer to the telephone base. You might have moved out of range.
- Reset the telephone base. Unplug the electrical power. Wait for 15 seconds then plug it back in. Allow up to one minute for the cordless handset and telephone base to reset.
- Other electronic products such as HAM radios and other DECT phones can cause interference with your cordless phone. Try installing your phone as far away as possible from these types of electronic devices.

The handset registration is unsuccessful.

Follow the steps below to register the handset again.

1. Make sure the handset is out of the charger and shows **Press [HOLD] on base for 4 sec, then press [#] on handset** before you begin.
2. Press and hold **HOLD** on the telephone base for about four seconds until it shows **Registering...Please wait**.
3. Press **#** (pound key) on the handset. Its screen shows **Registering handset...** and it takes up to 60 seconds to complete the registration. The handset shows **HANDSET X Registered** (X represents the handset number assigned) and you hear a beep when the registration is completed.

Refer to **Add and register a handset** on page 135 for details.

Troubleshooting

Out of range OR no power at base appears on my cordless handset.

- Make sure that the telephone base is powered up.
- Move the cordless handset closer to the telephone base. You might have moved out of range.
- Reset the telephone base. Unplug the electrical power. Wait for 15 seconds then plug it back in. Allow up to one minute for the cordless handset and telephone base to reset.
- Other electronic products such as HAM radios and other DECT phones can cause interference with your cordless phone. Try installing your phone as far away as possible from these types of electronic devices.

The batteries do not hold a charge.

- If the cordless handset is in the charger and the charge light does not come on, refer to **The charge light is off** (page 145) in this **Troubleshooting** guide.
- Charge the battery in the cordless handset for at least 16 hours. For optimum daily performance, return the cordless handset to the charger when not in use.
- If the battery is depleted, it may take approximately five minutes to charge the handset before you use it. See page 12 for details.
- You may need to purchase a new battery. Please refer to **Battery installation and charging** (pages 11-12) in this user's manual.

I get noise, static, or a weak signal even when I'm near the telephone base.

- If you subscribe to high-speed Internet service (DSL - digital subscriber line) through your telephone lines, you must install a DSL filter between each telephone line cord and telephone wall jack (pages 8-9). The filter prevents noise and caller ID problems caused by DSL interference. Please contact your DSL service provider for more information about DSL filters.
- You may be able to improve the performance of your cordless phone by installing your new telephone base as far as possible from any other existing cordless telephone system that may already be installed.
- Other electronic products such as HAM radios and other DECT phones can cause interference with your cordless phone. Try installing your phone as far away as possible from these types of electronic devices.

Troubleshooting

- Do not install this phone near a microwave oven or on the same electrical outlet. You may experience decreased performance while the microwave oven is operating.
- If your phone is plugged in with a modem or a surge protector, plug the phone (or modem/surge protector) into a different location. If this doesn't solve the problem, relocate your phone or modem farther apart from one another, or use a different surge protector.
- Relocate your phone to a higher location. The phone may have better reception when installed in a high area.
- If other phones in your home are having the same problem, the problem is in your wiring or local service. Contact your telephone service provider (charges may apply).

I experience poor sound quality when using the speakerphone.

- For increased sound quality while using the handset speakerphone, place the handset on a flat surface with the dial pad facing up.
- When using a speakerphone, controlling background noise in your environment is essential. While you are listening to your party, press the **MUTE** softkey to temporarily turn your microphone off. When it is your turn to speak, remember to press the **MUTE** softkey again to turn the microphone on.
- Excessive background noise will cause a speakerphone to fade in and out. Try controlling the background noise by turning off any audio devices near the speakerphone. Also, try to avoid interrupting the person at the other end of the conversation while they are speaking. If background noise cannot be controlled, you should terminate speakerphone operation and return to normal handset mode.

I hear other calls while using my phone.

- Disconnect the telephone base from the telephone jack, and plug in a different telephone. If you still hear other calls, the problem is probably in your wiring or telephone service. Call your telephone service provider.

While on a call or playing messages, there is too much noise, or the voice sounds tinny, shrill or flat.

- While on a call or playing messages, press the **EQ**  button on the side of the handset until you find the settings that sounds the best (page 77).

My cordless handset does not ring when I receive a call.

- Make sure that the ringer is not turned off. Refer to **Ringer volume** on page 31 in this user's manual.
- Make sure the telephone line cord is plugged securely into the telephone base and the telephone jack. Make sure the power cord is securely plugged in.
- The cordless handset may be too far from the telephone base.
- Charge the battery in the cordless handset for at least 16 hours. For optimum daily performance, return the cordless handset to the charger when not in use.
- You may have too many extension phones on your telephone line to allow all of them to ring simultaneously. Try unplugging some of the other phones.
- The layout of your home or office might be limiting the operating range. Try moving the telephone base to another location, preferably to a higher location.
- If other phones in your home are having the same problem, the problem is in your wiring or local service. Contact your telephone service provider (charges may apply).
- Test a working phone at the phone jack. If the other phone has the same problem, the problem is the phone jack. Contact your telephone service provider (charges may apply).
- Other electronic products such as HAM radios and other DECT phones can cause interference with your cordless phone. Try installing your phone as far away as possible from these types of electronic devices.
- Remove and install the battery again. Wait for the cordless handset to reestablish its connection with the telephone base. Allow up to one minute for this to take place.
- Your line cord may be defective. Try installing a new line cord.

Troubleshooting

My calls cut in and out while I'm using my cordless handset.

- Other electronic products such as HAM radios and other DECT phones can cause interference with your cordless phone. Try installing your phone as far away as possible from these types of electronic devices.
- Do not install this phone near a microwave oven or on the same electrical outlet. You may experience decreased performance while the microwave oven is operating.
- If you plug your phone in with a modem or surge protector, plug the phone (or modem/surge protector) into a different location. If this doesn't solve the problem, relocate your phone or modem farther apart from one another, or use a different surge protector.
- Relocate your telephone base to a higher location. The phone may have better reception when installed in a high area.
- If other phones in your home are having the same problem, the problem is in your wiring or telephone service. Contact your telephone service provider (charges may apply).
- Excessive background noise will cause a speakerphone to fade in and out. Try controlling the background noise by turning off any audio devices near the speakerphone. Also, try to avoid interrupting the person at the other end of the conversation while they are speaking. If background noise cannot be controlled, you should stop speakerphone operation and return to normal handset mode.
- When using a speakerphone, controlling background noise in your environment is essential. While you are listening to your party, press the **MUTE** softkey to temporarily turn your microphone off. When it is your turn to speak, remember to press the **MUTE** softkey to turn the microphone on.

The charge light is off.

- Make sure the power and line cords are plugged in correctly and securely.
- Unplug the electrical power. Wait for 15 seconds, then plug it back in. Allow up to one minute for the cordless handset and telephone base to reset.
- Clean the cordless handset and charger charging contacts each month using a pencil eraser or cloth.

Troubleshooting

My caller ID isn't working.

- Caller ID is a subscription service. You must subscribe to this service from your telephone service provider for this feature to work on your phone.
- The caller must be calling from an area that supports caller ID.
- Both your and your caller's telephone service providers must use caller ID compatible equipment.
- If you subscribe to high-speed Internet service (DSL - digital subscriber line) through your telephone lines, you must install a DSL filter between each telephone line cord and telephone wall jack (pages 8-9). The filter prevents noise and caller ID problems caused by DSL interference. Please contact your DSL service provider for more information about DSL filters.

My telephone does not receive caller ID when on a call.

- Make sure you subscribe to caller ID with call waiting features provided by your telephone service provider. Caller ID features work only if both you and the caller are in areas offering caller ID service, and if both telephone companies use compatible equipment.

Voicemail and show on the display and I don't know why.

- Your telephone has voicemail indication that is separate from the built-in answering system. If **Voicemail** and  display on the cordless handset and telephone base, then your telephone has received a signal from your telephone service provider that you have a voicemail message waiting for you to retrieve from your telephone service provider. Contact your telephone service provider for more information on how to access your voicemail.

I cannot retrieve voicemail messages.

- Your telephone has both a built-in answering system and voicemail indication. They are independent features and each alerts you to new messages differently (page 117). If you subscribe to voicemail service from your telephone service provider (charges may apply), contact your telephone service provider for more information on how to access your voicemail.

I am receiving incomplete messages.

- If a caller leaves a very long message, part of it may be lost when the system disconnects the call after the recording time you set (see **Recording time** on page 65).
- If the caller pauses for longer than seven seconds, the system stops recording and disconnects the call.
- If the system's memory becomes full while recording a message, the system stops recording and disconnect the call.
- If the caller's voice is very soft, the system may stop recording and disconnect the call.

Troubleshooting

I am having difficulty in hearing messages.

- Press **VOLUME ▲** to increase speaker volume on the telephone base.
- Press **▲/VOL** to increase the listening volume on a handset.

The answering system does not answer after the correct number of rings.

- Make sure the answering system is on. When the answering system is on, **OO** with line 1 or line 2 indicator should show on the cordless handset and telephone base. **📞/ON/OFF LINE 1** or **📞/ON/OFF LINE 2** light is lit on the telephone base (page 60).
- If toll saver is selected, the number of rings changes to two when there are new messages waiting (page 62).
- If the memory is full or the system is off, the system answers after 10 rings.
- In some cases, the answering system is affected by the ringing system used by the telephone service provider.
- If you subscribe to voicemail service, change the number of rings so that your answering system answers before your voicemail answers (page 117). To determine how many rings activate your voicemail, contact your telephone service provider.
- If there is a fax machine connected to the same telephone line, try disconnecting the fax machine. If that solves the problem, consult your fax machine documentation for information on compatibility with answering systems.

The answering system announces “Time and day not set.”

- You need to set the date and time (pages 37 and 47).

The answering system does not respond to remote commands.

- Make sure to enter your remote access code correctly (page 125).
- Make sure you are calling from a touch-tone phone. When you dial a number, you should hear tones. If you hear clicks, the phone is not a touch-tone telephone and cannot activate the answering system.
- The answering system may not detect the remote access code while your announcement is playing. Try waiting until the announcement is over before entering the code.
- There may be interference on the phone line you are using. Press the dial pad keys firmly.

The answering system does not record messages.

- Make sure the answering system is on (page 60).
- Make sure the memory of the answering system is not full. When the answering machine memory is full, it does not record new messages until some old messages are deleted.
- If you subscribe to voicemail service, change the number of rings so that your answering system answers before your voicemail answers (page 117). To determine how many rings activate your voicemail, please contact your telephone service provider.
- If there is a fax machine connected to the same telephone line, try disconnecting the fax machine. If that solves the problem, consult your fax machine documentation for information on compatibility with answering systems.

The outgoing announcement is not clear.

- When you record your announcement, make sure you speak in a normal tone of voice, about nine inches from the telephone base.
- Make sure there is no background noise (TV, music, etc.) while recording.

I subscribe to a nontraditional telephone service that uses my computer to establish connections, and my telephone doesn't work.

- Make sure your computer is powered on.
- Make sure your Internet connection is working properly.
- Make sure that the software is installed and running for your nontraditional telephone service.
- Make sure to plug your USB telephone adapter into a dedicated USB port on your computer. Do not plug into a multiple port USB hub (USB splitter) that is not powered.
- In a few rare instances, the USB port on your computer may not have enough power. In these instances, try using a USB hub with its own external power supply.
- If you are using a firewall, it may prevent access to your nontraditional telephone service provider. Contact your service provider for more information.

Common cure for electronic equipment:

If the telephone is not responding normally, try resetting the telephone. Do the following in the order listed:

1. Disconnect the power to the telephone base.
2. Disconnect the cordless handset battery.
3. Wait a few minutes.
4. Connect power to the telephone base.
5. Install the battery again.
6. Wait for the cordless handset to reestablish its connection with the telephone base. Allow up to one minute for this to take place.

Maintenance

Taking care of your telephone

- Your telephone contains sophisticated electronic parts, so it must be treated with care.
- Avoid rough treatment.
- Place the handset down gently.
- Save the original packing materials to protect your telephone if you ever need to ship it.

Avoid water

- Your telephone can be damaged if it gets wet. Do not use the handset in the rain, or handle it with wet hands. Do not install the telephone base near a sink, bathtub or shower.

Electrical storms

- Electrical storms can sometimes cause power surges harmful to electronic equipment. For your own safety, take caution when using electric appliances during storms.

Cleaning your telephone

- Your telephone has a durable plastic casing that should retain its luster for many years. Clean it only with a soft cloth slightly dampened with water or a mild soap.
- Do not use excess water or cleaning solvents of any kind.

Remember that electrical appliances can cause serious injury if used when you are wet or standing in water. If the telephone base should fall into water, DO NOT RETRIEVE IT UNTIL YOU UNPLUG THE POWER CORD AND TELEPHONE LINE CORDS FROM THE WALL. Then pull the telephone out by the unplugged cords.

Important safety information



This symbol is to alert you to important operating or servicing instructions that may appear in this user's manual. Always follow basic safety precautions when using this product to reduce the risk of injury, fire, or electric shock.

Safety information

- Read and understand all instructions in the user's manual. Observe all markings on the product.
- Avoid using a telephone during a thunderstorm. There might be a slight chance of electric shock from lightning.
- Do not use a telephone in the vicinity of a gas leak. Under certain circumstances, a spark may be created when the adapter is plugged into the power outlet, or when the handset is replaced in its cradle. This is a common event associated with the closing of any electrical circuit. The user should not plug the phone into a power outlet, and should not put a charged handset into the cradle, if the phone is located in an environment containing concentrations of flammable or flame-supporting gases, unless there is adequate ventilation. A spark in such an environment could create a fire or explosion. Such environments might include: medical use of oxygen without adequate ventilation; industrial gases (cleaning solvents; gasoline vapors; etc.); a leak of natural gas; etc.
- Do not use this product near water, or when you are wet. For example, do not use it in a wet basement or shower, or next to a swimming pool, bathtub, kitchen sink, or laundry tub. Do not use liquids or aerosol sprays for cleaning. If the product comes in contact with any liquids, unplug any line or power cord immediately. Do not plug the product back in until it has dried thoroughly.
- Install this product in a protected location where no one can trip over any line or power cords. Protect cords from damage or abrasion.
- If this product does not operate normally, read the **Troubleshooting** section on pages 137-149 of this user's manual. If you cannot solve the problem, or if the product is damaged, refer to the **Limited warranty** section on pages 155-156. Do not open this product except as may be directed in your user's manual. Opening the product or reassembling it incorrectly may expose you to hazardous voltages or other risks.
- Replace batteries only as described in your user's manual (page 11). Do not burn or puncture batteries — they contain caustic chemicals.
- This power adapter is intended to be correctly oriented in a vertical or floor mount position. The prongs are not designed to hold the plug in place if it is plugged into a ceiling, under-the-table or cabinet outlet.



CAUTION: Use only the power adapter provided with this product. To obtain a replacement, visit our website at www.telephones.att.com, or call **1 (800) 222-3111**.

In Canada, dial **1 (866) 288-4268**.

Especially about corded telephones

- Privacy: The same features that make a cordless telephone convenient create some limitations. Telephone calls are transmitted between the telephone base and the handset by radio waves, so there is a possibility that your cordless telephone conversations could be intercepted by radio receiving equipment within range of the cordless handset. For this reason, you should not think of cordless telephone conversations as being as private as those on corded telephones.

Important safety information

- **Electrical power:** The telephone base of this cordless telephone must be connected to a working electrical outlet which is not controlled by a wall switch. Calls cannot be made from the handset if the telephone base is unplugged, switched off or if the electrical power is interrupted.
- **Potential TV interference:** Some cordless telephones operate at frequencies that may cause interference to TVs and VCRs. To minimize or prevent such interference, do not place the telephone base of the cordless telephone near or on top of a TV or VCR. If interference is experienced, moving the cordless telephone farther away from the TV or VCR will often reduce or eliminate the interference.
- **Rechargeable batteries:** This product contains nickel-metal hydride rechargeable batteries. Exercise care in handling batteries in order not to create a short circuit with conductive material such as rings, bracelets, and keys. The battery or conductor may overheat and cause harm. Observe proper polarity between the battery and the battery charger.
- **Nickel-metal hydride rechargeable batteries:** Dispose of these batteries in a safe manner. Do not burn or puncture. Like other batteries of this type, if burned or punctured, they could release caustic material which could cause injury.



The RBRC™ Seal means that the manufacturer is voluntarily participating in an industry program to collect and recycle nickel-metal hydride rechargeable batteries when taken out of service within the United States. These batteries may be taken to a participating local retailer of replacement batteries or recycling center. Or you may call 1 (800) 8-BATTERY for locations accepting spent Ni-MH batteries.

Precautions for users of implanted cardiac pacemakers

Cardiac pacemakers (applies only to digital cordless telephones): Wireless Technology Research, LLC (WTR), an independent research entity, led a multidisciplinary evaluation of the interference between portable wireless telephones and implanted cardiac pacemakers. Supported by the U.S. Food and Drug Administration, WTR recommends to physicians that:

Pacemaker patients

- Should keep wireless telephones at least six inches from the pacemaker.
- Should NOT place wireless telephones directly over the pacemaker, such as in a breast pocket, when it is turned ON.
- Should use the wireless telephone at the ear opposite the pacemaker.

WTR's evaluation did not identify any risk to bystanders with pacemakers from other persons using wireless telephones.

Especially about telephone answering systems

Two-way recording: This unit does not sound warning beeps to inform the other party that the call is being recorded. To ensure that you are in compliance with any federal or state regulations regarding recording a telephone call, you should start the recording process and then inform the other party that you are recording the conversation.

SAVE THESE INSTRUCTIONS

FCC Part 68 and ACTA

This equipment complies with Part 68 of the FCC rules and with technical requirements adopted by the Administrative Council for Terminal Attachments (ACTA). The label on the back or bottom of this equipment contains, among other things, a product identifier in the format US:AAAEQ##TXXXX. This identifier must be provided to your telephone service provider upon request.

The plug and jack used to connect this equipment to premises wiring and the telephone network must comply with the applicable Part 68 rules and technical requirements adopted by ACTA. A compliant telephone cord and modular plug is provided with this product. It is designed to be connected to a compatible modular jack that is also compliant. An RJ11 jack should normally be used for connecting to a single line and an RJ14 jack for two lines. See the installation instructions in the user's manual.

The Ringer Equivalence Number (REN) is used to determine how many devices you may connect to your telephone line and still have them ring when you are called. The REN for this product is encoded as the 6th and 7th characters following the US: in the product identifier (e.g., if ## is 03, the REN is 0.3). In most, but not all areas, the sum of all RENs should be five (5.0) or less. For more information, please contact your telephone service provider.

This equipment may not be used with Party Lines. If you have specially wired alarm dialing equipment connected to your telephone line, ensure the connection of this equipment does not disable your alarm equipment. If you have questions about what will disable the alarm equipment, consult your telephone service provider or a qualified installer.

If this equipment is malfunctioning, it must be unplugged from the modular jack until the problem has been corrected. Repairs to this telephone equipment can only be made by the manufacturer or its authorized agents. For repair procedures, follow the instructions outlined under the Limited warranty.

If this equipment is causing harm to the telephone network, the telephone service provider may temporarily discontinue your telephone service. The telephone service provider is required to notify you before interrupting service. If advance notice is not practical, you will be notified as soon as possible. You will be given the opportunity to correct the problem and the telephone service provider is required to inform you of your right to file a complaint with the FCC. Your telephone service provider may make changes in its facilities, equipment, operation, or procedures that could affect the proper functioning of this product. The telephone service provider is required to notify you if such changes are planned.

If this product is equipped with a corded or cordless handset, it is hearing aid compatible.

If this product has memory dialing locations, you may choose to store emergency telephone numbers (e.g., police, fire, medical) in these locations. If you do store or test emergency numbers, please:

- Remain on the line and briefly explain the reason for the call before hanging up.
- Perform such activities in off-peak hours, such as early morning or late evening.

Industry Canada

Operation is subject to the following two conditions: (1) this device may not cause harmful interference, and (2) this device must accept any interference, including interference that may cause undesired operation.

The term "IC:" before the certification/registration number only signifies that the Industry Canada technical specifications were met.

The Ringer Equivalence Number (REN) for this terminal equipment is 0.7. The REN is an indication of the maximum number of devices allowed to be connected to a telephone interface. The termination on an interface may consist of any combination of devices subject only to the requirement that the sum of the RENs of all the devices does not exceed five.

This product meets the applicable Industry Canada technical specifications.

Appendix FCC Part 15

This equipment has been tested and found to comply with the requirements for a Class B digital device under Part 15 of the Federal Communications Commission (FCC) rules.

These requirements are intended to provide reasonable protection against harmful interference in a residential installation. This equipment generates, uses and can radiate radio frequency energy and, if not installed and used in accordance with the instructions, may cause harmful interference to radio communications. However, there is no guarantee that interference will not occur in a particular installation.

If this equipment does cause harmful interference to radio or television reception, which can be determined by turning the equipment off and on, the user is encouraged to try to correct the interference by one or more of the following measures:

- Reorient or relocate the receiving antenna.
- Increase the separation between the equipment and receiver.
- Connect the equipment into an outlet on a circuit different from that to which the receiver is connected.
- Consult the dealer or an experienced radio/TV technician for help.

Changes or modifications to this equipment not expressly approved by the party responsible for compliance could void the user's authority to operate the equipment.

This device complies with Part 15 of the FCC rules. Operation is subject to the following two conditions: (1) this device may not cause harmful interference, and (2) this device must accept any interference received, including interference that may cause undesired operation. Privacy of communications may not be ensured when using this telephone.

To ensure safety of users, the FCC has established criteria for the amount of radio frequency energy that can be safely absorbed by a user or bystander according to the intended usage of the product. This product has been tested and found to comply with the FCC criteria. The handset may be safely held against the ear of the user. The telephone base shall be installed and used such that parts of the user's body other than the hands are maintained at a distance of approximately 20cm (8 inches) or more. If you choose to use a clipping device, please make sure to only use the supplied AT&T belt clip.

This Class B digital apparatus complies with Canadian ICES-003.

For body worn operation, this handset has been tested and meets FCC RF exposure guidelines when used with an accessory that contains no metal and that positions the handset a minimum of (0mm) from the body.

Use of other accessories may not ensure compliance with FCC RF exposure guidelines.

Appendix Limited warranty

The AT&T brand is used under license - any repair, replacement or warranty service, and all questions about this product should be directed to: In the United States of America, call

1 (800) 222-3111 or visit **www.telephones.att.com**; in Canada, call **1 (866) 288-4268**.

1. What does this limited warranty cover?

The manufacturer of this AT&T branded product warrants to the holder of a valid proof of purchase ("CONSUMER" or "you") that the product and all accessories provided in the sales package ("PRODUCT") are free from defects in material and workmanship, pursuant to the following terms and conditions, when installed and used normally and in accordance with the PRODUCT operating instructions. This limited warranty extends only to the CONSUMER for products purchased and used in the United States of America and Canada.

2. What will be done if the PRODUCT is not free from defects in materials and workmanship during the limited warranty period ("materially defective PRODUCT")?

During the limited warranty period, the manufacturer's authorized service representative repairs or replaces at the manufacturer's option, without charge, a materially defective PRODUCT. If the manufacturer repairs the PRODUCT, they may use new or refurbished replacement parts. If the manufacturer chooses to replace the PRODUCT, they may replace it with a new or refurbished PRODUCT of the same or similar design. The manufacturer will retain the defective parts, modules, or equipment. Repair or replacement of the PRODUCT, at the manufacturer's option, is your exclusive remedy. The manufacturer returns the repaired or replacement products to you in working condition. You should expect the repair or replacement to take approximately 30 days.

3. How long is the limited warranty period?

The limited warranty period for the PRODUCT extends for ONE (1) YEAR from the date of purchase. If the manufacturer repairs or replaces a materially defective PRODUCT under the terms of this limited warranty, this limited warranty also applies to repaired or replacement PRODUCT for a period of either (a) 90 days from the date the repaired or replacement PRODUCT is shipped to you or (b) the time remaining on the original one-year limited warranty; whichever is longer.

4. What is not covered by this limited warranty?

This limited warranty does not cover:

- PRODUCT that has been subjected to misuse, accident, shipping or other physical damage, improper installation, abnormal operation or handling, neglect, inundation, fire, water, or other liquid intrusion; or
- PRODUCT that has been damaged due to repair, alteration, or modification by anyone other than an authorized service representative of the manufacturer; or
- PRODUCT to the extent that the problem experienced is caused by signal conditions, network reliability or cable or antenna systems; or
- PRODUCT to the extent that the problem is caused by use with non-AT&T accessories; or
- PRODUCT whose warranty/quality stickers, PRODUCT serial number plates or electronic serial numbers have been removed, altered or rendered illegible; or
- PRODUCT purchased, used, serviced, or shipped for repair from outside the United States of America or Canada, or used for commercial or institutional purposes (including but not limited to products used for rental purposes); or
- PRODUCT returned without a valid proof of purchase (see item 6 below); or
- Charges for installation or setup, adjustment of customer controls, and installation or repair of systems outside the unit.

Limited warranty

5. How do you get warranty service?

To obtain warranty service in the United States of America, visit

www.telephones.att.com or call **1 (800) 222-3111**; in Canada, please

dial **1 (866) 288-4268**. NOTE: Before calling for service, please review the user's manual. A check of the PRODUCT's controls and features might save you a service call.

Except as provided by applicable law, you assume the risk of loss or damage during transit and transportation and are responsible for delivery or handling charges incurred in the transport of the PRODUCT(s) to the service location. The manufacturer will return repaired or replaced PRODUCT under this limited warranty. Transportation, delivery or handling charges are prepaid. The manufacturer assumes no risk for damage or loss of the PRODUCT in transit. If the PRODUCT failure is not covered by this limited warranty, or proof of purchase does not meet the terms of this limited warranty, the manufacturer notifies you and requests that you authorize the cost of repair prior to any further repair activity. You must pay for the cost of repair and return shipping costs for the repair of products that are not covered by this limited warranty.

6. What must you return with the PRODUCT to get warranty service?

You must:

- Return the entire original package and contents including the PRODUCT to the service location along with a description of the malfunction or difficulty; and
- Include a "valid proof of purchase" (sales receipt) identifying the PRODUCT purchased (PRODUCT model) and the date of purchase or receipt; and
- Provide your name, complete and correct mailing address, and telephone number.

7. Other limitations

This warranty is the complete and exclusive agreement between you and the manufacturer of this AT&T branded PRODUCT. It supersedes all other written or oral communications related to this PRODUCT. The manufacturer provides no other warranties for this PRODUCT. The warranty exclusively describes all of the manufacturer's responsibilities regarding the PRODUCT. There are no other express warranties. No one is authorized to make modifications to this limited warranty and you should not rely on any such modification.

State/Provincial Law Rights: This warranty gives you specific legal rights, and you might also have other rights that vary from state to state or province to province.

Limitations: Implied warranties, including those of fitness for a particular purpose and merchantability (an unwritten warranty that the PRODUCT is fit for ordinary use) are limited to one year from date of purchase. Some states/provinces do not allow limitations on how long an implied warranty lasts, so the above limitation might not apply to you. In no event shall the manufacturer be liable for any indirect, special, incidental, consequential, or similar damages (including, but not limited to lost profits or revenue, inability to use the PRODUCT or other associated equipment, the cost of substitute equipment, and claims by third parties) resulting from the use of this PRODUCT. Some states/provinces do not allow the exclusion or limitation of incidental or consequential damages, so the above limitation or exclusion might not apply to you.

Please retain your original sales receipt as proof of purchase.

Technical specifications

RF frequency band	1921.536MHz — 1928.448MHz
Channels	5
Operating temperature	32°F — 122°F 0°C — 50°C
Telephone base voltage (AC voltage, 60Hz)	96 — 129 Vrms
Telephone base voltage (AC adapter output)	6VDC @600mA
Handset voltage	2.4 — 3.2 VDC
Charger voltage (AC adapter output)	6VAC @300mA
Replacement battery	2.4V 750mAH
Operating times*	Talk time (handset): up to seven hours Talk time (speakerphone): up to five hours Standby: up to seven days

* Operating times vary depending on your actual use and the age of the battery.

DECT 6.0 digital technology

The AT&T DECT 6.0 products offer unsurpassed range performance and sound clarity. This is achieved through a unique antenna design and advances in noise-filtering technology. An independent laboratory has confirmed that AT&T DECT 6.0 products perform up to 45% better in range competitions against similarly equipped phones of the leading competition. Now calls can be taken in the basement, backyard and garage with exceptional sound quality.

Telephone operating range

This cordless telephone operates within the maximum power allowed by the Federal Communications Commission (FCC). Even so, this handset and telephone base can communicate over only a certain distance — which can vary with the locations of the telephone base and handset, the weather, and the construction of your home or office.

Extended range and clarity

This telephone base comes with an antenna which gives much better clarity and covers a longer range than before.

A

Active devices, 22
Add a Bluetooth headset, 18
Add a cell phone, 16
Add a DECT 6.0 cordless headset, 133
Add a device on the active devices list, 25
Add a handset, 135
Alert tones, 128
Alphabetical search, 99
Answer a cell call, 68
Answer a cell call while on a home call, 70
Answer a home call, 66
Answer a home call while on a cell call, 71
Answer an incoming call during an intercom call, 88
Answer an incoming call while on a conference call, 73
Answering system and voicemail, 117
Answering system settings, 51
Answer on/off, 59
Appendix, 126

B

Battery charging, 11
Battery installation, 11
Bluetooth glossary, 15
Bluetooth operation, 14
Bluetooth setup, 16

C

Caller ID, 108
Caller ID history, 109
Call intercept, 119
Call log, 109
Call log display screen messages, 116
Call screening, 119
Call waiting on the cell line, 69
Call waiting on the home line, 68
Cell area code, 40, 50
Cell call, 68

Cell phone download directory, 28
Chain dialing, 78
Change PIN, 27
Charger installation, 10
Charging, 12
Clear the voicemail indication, 34, 44
Clock, 11, 37, 47
Conference calls, 72, 73, 74
Connect an active device, 23
Create a new directory entry, 93

D

Data port use, 10
Date, 11, 37, 47
DECT 6.0 cordless headset, 133
Delete a directory entry, 103
Delete all old messages, 122
Delete a message, 120, 121
Delete a redial entry, 82
Delete the announcement, 58
Deregister a DECT 6.0 cordless headset, 133
Deregister handsets, 136
Dial-in-Base Speakerphone, 75
Dial a call log entry, 112
Dial a directory entry, 100
Dial mode, 38, 48
Directory, 28, 92
Disconnect an active device, 23
Download directory, 28
DSL filter, 8

E

Edit a directory entry, 101
Edit the type of a directory entry, 103
End a cell call, 68
End a home call, 66
End mute, 76
Equalizer, 77
Expand your telephone system, 135

F

Fax machine, 10
Flash (switch hook flash), 68

G

Glossary, 15

H

Handset icons, 126
Handset lights, 128
Handset locator, 83
Handset ringer volume, 31
Handset settings, 31
Headset, 13, 18, 67, 133
Hold, 77
Home area code, 39, 49
Home directory, 93

I

Icons, 126
Important safety information, 151
Indicators, 128
Installation, 7
Intercom, 85
Interruption to directory
download, 29

J

Join a call, 84

K

Key tone, 36, 46

L

Language, 32, 42
Last number redial, 80
LCD Language, 32, 42
Lights, 128
Limited warranty, 155
Listening volume, 75

M

Maintenance, 150
Make a cell call, 68
Make a home call, 66
Memory match, 110
Memos, 123
Message alert tone, 64
Message capacity, 118

Message playback, 120
Missed call indicator, 109
Mute, 76

N

New message indicator, 118
Number of rings, 62

O

Operating range, 157

P

Paging, 83
Pair a cell phone, 16
Pair a headset, 18
Paired devices, 20
Phonebook (directory), 92
Play announcement, 55
Play memos, 123
Predialing, 66

Q

Quick reference guide, 1

R

Record an announcement, 56
Redial list, 80
Register a DECT 6.0 cordless
headset, 133
Register a handset, 135
Remote access code, 125
Remove a downloaded directory, 104
Remove an active device, 26
Remove a paired device, 21
Rename a paired device, 20
Repeat messages, 120, 121
Replace a handset, 136
Replace an active device, 24
Review the active devices list, 22
Review the directory, 98
Review the redial list, 80
Ringer mute, 75
Ringer tone, 32, 42
Ringer volume, 31, 41

S

- Safety information, 151
- Save a call log entry to the directory, 113
- Save a redial entry to the directory, 81
- Screen display messages, 130
- Search for a contact, 99
- Set date/time, 11, 37, 47
- Set the announcement mode, 51, 52
- Set the time schedules of the announcements, 53, 54
- Share an outside call, 84
- Silence the ringer, 75
- Skip messages, 120, 121
- Speakerphone, 75
- Stop messages, 120, 121

T

- Take a call off mute, 76
- Technical specifications, 157
- Telephone base installation, 8
- Telephone base ringer volume, 41
- Telephone operating range, 157
- Telephone operation, 66
- Telephone settings, 31
- Temporary tone dialing, 76
- Time, 11, 37, 47
- Toll saver, 62
- Transfer an outside call to the DECT 6.0 cordless headset, 134
- Troubleshooting, 137
- Turn on or off the answering system, 59

U

- Use a Bluetooth headset, 67
- Using the home and cell lines together, 74

V

- View the directory download information, 30
- Voicemail, 34, 44, 117, 120, 121
- Volume, 31, 41, 75

W

- Warranty, 155
- Website, 38, 49

Remote access wallet card

The wallet card below lists the commands needed to control your answering system from any touch-tone telephone.

Cut along dotted line.



Call your telephone number, then enter your two-digit remote access code (preset to **19**).

Action	Remote command
--------	----------------

- | | |
|-------------------------------|------------------------------------|
| Play all messages | 1 |
| Play new messages..... | 2 |
| Delete the message..... | 3 (during message playback) |
| Delete all old messages | 33 |
| Repeat or go back..... | 4 |
| Stop..... | 5 |

Fold here.

- | | |
|---|-------------------------|
| Help menu | X 5 |
| Skip the message..... | 6 |
| Record Annc A | X 7 |
| Record Annc B | X 8 |
| End remote access call..... | X 9 (or hang up) |
| Turn the answering system on or off | 0 |

TL86109 DECT 6.0 2-line corded/cordless telephone/answering system with BLUETOOTH® wireless technology

© 2010-2011 Advanced American Telephones. All Rights Reserved. AT&T and the AT&T logo are trademarks of AT&T Intellectual Property licensed to Advanced American Telephones, San Antonio, TX 78219. Printed in China.



www.telephones.att.com

The *Bluetooth*[®] word mark and logos are owned by Bluetooth SIG, Inc. and any use of such marks by Advanced American Telephones and its parent, VTech Holdings Limited, is under license. VTech Holdings Limited is a member of Bluetooth SIG, Inc. Other trademarks and trade names are those of their respective owners.

© 2010-2011 Advanced American Telephones. All Rights Reserved.
AT&T and the AT&T logo are trademarks of AT&T Intellectual Property licensed to
Advanced American Telephones, San Antonio, TX 78219.
Printed in China. Issue 8 AT&T 08/11.